

HP103 Roland Digital Piano

Owner's Manual

Thank you, and congratulations on your choice of the Roland Digital Piano HP103.

Main Features

Piano Sounds with Rich Resonance and Wide-ranging Expressiveness

The stereo sampling piano sound generator realistically reproduces even the sound of the hammers striking the strings, producing the tones of a high-quality concert grand piano. Maximum polyphony of 64 notes ensures that you can use the pedal freely without running out of notes.

In addition, this instrument features a "Grand Sound" speaker system, and simulates the full, three-dimensional nature of a concert grand piano (Grand Space), which together help to deliver a sound with even greater clarity and power (Dynamic Emphasis).

Pursuing the Playing Feel of a Grand Piano

This instrument features a progressive hammer action keyboard, which duplicates the touch of a grand piano, with a heavier touch in the lower register, and a lighter touch in the upper register.

The pedal is designed for good-feeling response, and allows subtle performance nuances to be expressed.

Comfortable for Use with Headphones



Special effects applied to the sound when headphones are used make listening through headphones comfortable, not fatiguing. And in addition to an indicator on the front panel that lights up when you connect a pair of headphones, the HP103 also provides a convenient hook where you can keep your headphones when they're not in use.

A Variety of Helpful Practice Features and Built-in Piano Songs

A metronome function and "two-track recorder," the built-in songs for a collection of scores (60 songs included), and other features let you experience piano lessons in ways possible only with a digital piano.

Before using this unit, carefully read the sections entitled: "IMPORTANT SAFETY INSTRUCTIONS" (p. 2), "USING THE UNIT SAFELY" (p. 3, 4), and "IMPORTANT NOTES" (p. 5, 6). These sections provide important information concerning the proper operation of the unit. Additionally, in order to feel assured that you have gained a good grasp of every feature provided by your new unit, Owner's manual should be read in its entirety. The manual should be saved and kept on hand as a convenient reference.

WARNING: To reduce the risk of fire or electric shock, do not expose this apparatus to rain or moisture.

	CAUTION RISK OF ELECTRIC SHOCK DO NOT OPEN	
ATTENTION: RISQUE DE CHOC ELECTRIQUE NE PAS OUVRIR		
CAUTION: TO REDUCE THE RISK OF ELECTRIC SHOCK, DO NOT REMOVE COVER (OR BACK). NO USER-SERVICEABLE PARTS INSIDE. REFER SERVICING TO QUALIFIED SERVICE PERSONNEL.		



The lightning flash with arrowhead symbol, within an equilateral triangle, is intended to alert the user to the presence of uninsulated "dangerous voltage" within the product's enclosure that may be of sufficient magnitude to constitute a risk of electric shock to persons.



The exclamation point within an equilateral triangle is intended to alert the user to the presence of important operating and maintenance (servicing) instructions in the literature accompanying the product.

INSTRUCTIONS PERTAINING TO A RISK OF FIRE, ELECTRIC SHOCK, OR INJURY TO PERSONS.

IMPORTANT SAFETY INSTRUCTIONS SAVE THESE INSTRUCTIONS

WARNING - When using electric products, basic precautions should always be followed, including the following:

1. Read these instructions.
2. Keep these instructions.
3. Heed all warnings.
4. Follow all instructions.
5. Do not use this apparatus near water.
6. Clean only with a dry cloth.
7. Do not block any of the ventilation openings. Install in accordance with the manufacturers instructions.
8. Do not install near any heat sources such as radiators, heat registers, stoves, or other apparatus (including amplifiers) that produce heat.
9. Do not defeat the safety purpose of the polarized or grounding-type plug. A polarized plug has two blades with one wider than the other. A grounding type plug has two blades and a third grounding prong. The wide blade or the third prong are provided for your safety. When the provided plug does not fit into your outlet, consult an electrician for replacement of the obsolete outlet.
10. Protect the power cord from being walked on or pinched particularly at plugs, convenience receptacles, and the point where they exit from the apparatus.
11. Only use attachments/accessories specified by the manufacturer.
12. Never use with a cart, stand, tripod, bracket, or table except as specified by the manufacturer, or sold with the apparatus. When a cart is used, use caution when moving the cart/apparatus combination to avoid injury from tip-over.
13. Unplug this apparatus during lightning storms or when unused for long periods of time.
14. Refer all servicing to qualified service personnel. Servicing is required when the apparatus has been damaged in any way, such as power-supply cord or plug is damaged, liquid has been spilled or objects have fallen into the apparatus, the apparatus has been exposed to rain or moisture, does not operate normally, or has been dropped.



For the U.K.

IMPORTANT: THE WIRES IN THIS MAINS LEAD ARE COLOURED IN ACCORDANCE WITH THE FOLLOWING CODE.

BLUE: NEUTRAL
BROWN: LIVE

As the colours of the wires in the mains lead of this apparatus may not correspond with the coloured markings identifying the terminals in your plug, proceed as follows:
The wire which is coloured BLUE must be connected to the terminal which is marked with the letter N or coloured BLACK.
The wire which is coloured BROWN must be connected to the terminal which is marked with the letter L or coloured RED.
Under no circumstances must either of the above wires be connected to the earth terminal of a three pin plug.

USING THE UNIT SAFELY

INSTRUCTIONS FOR THE PREVENTION OF FIRE, ELECTRIC SHOCK, OR INJURY TO PERSONS

About ⚠ WARNING and ⚠ CAUTION Notices

⚠ WARNING	Used for instructions intended to alert the user to the risk of death or severe injury should the unit be used improperly.
⚠ CAUTION	Used for instructions intended to alert the user to the risk of injury or material damage should the unit be used improperly. * Material damage refers to damage or other adverse effects caused with respect to the home and all its furnishings, as well to domestic animals or pets.

About the Symbols

	The ⚠ symbol alerts the user to important instructions or warnings. The specific meaning of the symbol is determined by the design contained within the triangle. In the case of the symbol at left, it is used for general cautions, warnings, or alerts to danger.
	The ⓧ symbol alerts the user to items that must never be carried out (are forbidden). The specific thing that must not be done is indicated by the design contained within the circle. In the case of the symbol at left, it means that the unit must never be disassembled.
	The ⓧ symbol alerts the user to things that must be carried out. The specific thing that must be done is indicated by the design contained within the circle. In the case of the symbol at left, it means that the power-cord plug must be unplugged from the outlet.

ALWAYS OBSERVE THE FOLLOWING

⚠ WARNING

- Before using this unit, make sure to read the instructions below, and the Owner's Manual.
- Do not open or perform any internal modifications on the unit.
- Do not attempt to repair the unit, or replace parts within it (except when this manual provides specific instructions directing you to do so). Refer all servicing to your retailer, the nearest Roland Service Center, or an authorized Roland distributor, as listed on the "Information" page.
- Never use or store the unit in places that are:
 - Subject to temperature extremes (e.g., direct sunlight in an enclosed vehicle, near a heating duct, on top of heat-generating equipment); or are
 - Damp (e.g., baths, washrooms, on wet floors); or are
 - Humid; or are
 - Exposed to rain; or are
 - Dusty; or are
 - Subject to high levels of vibration.
- Make sure you always have the unit placed so it is level and sure to remain stable. Never place it on stands that could wobble, or on inclined surfaces.
- The unit should be connected to a power supply only of the type described in the operating instructions, or as marked on the bottom of unit.
- Use only the attached power-supply cord. Also, the supplied power cord must not be used with any other device.

⚠ WARNING

- Do not excessively twist or bend the power cord, nor place heavy objects on it. Doing so can damage the cord, producing severed elements and short circuits. Damaged cords are fire and shock hazards!
- This unit, either alone or in combination with an amplifier and headphones or speakers, may be capable of producing sound levels that could cause permanent hearing loss. Do not operate for a long period of time at a high volume level, or at a level that is uncomfortable. If you experience any hearing loss or ringing in the ears, you should immediately stop using the unit, and consult an audiologist.
- Do not allow any objects (e.g., flammable material, coins, pins); or liquids of any kind (water, soft drinks, etc.) to penetrate the unit.
- Immediately turn the power off, remove the power cord from the outlet, and request servicing by your retailer, the nearest Roland Service Center, or an authorized Roland distributor, as listed on the "Information" page when:
 - The power-supply cord, or the plug has been damaged; or
 - If smoke or unusual odor occurs
 - Objects have fallen into, or liquid has been spilled onto the unit; or
 - The unit has been exposed to rain (or otherwise has become wet); or
 - The unit does not appear to operate normally or exhibits a marked change in performance.

⚠ WARNING

- In households with small children, an adult should provide supervision until the child is capable of following all the rules essential for the safe operation of the unit. 

- Protect the unit from strong impact. (Do not drop it!) 

- Do not force the unit's power-supply cord to share an outlet with an unreasonable number of other devices. Be especially careful when using extension cords—the total power used by all devices you have connected to the extension cord's outlet must never exceed the power rating (watts/amperes) for the extension cord. Excessive loads can cause the insulation on the cord to heat up and eventually melt through. 

- Before using the unit in a foreign country, consult with your retailer, the nearest Roland Service Center, or an authorized Roland distributor, as listed on the "Information" page. 

- Do not put anything that contains water (e.g., flower vases) on this unit. Also, avoid the use of insecticides, perfumes, alcohol, nail polish, spray cans, etc., near the unit. Swiftly wipe away any liquid that spills on the unit using a dry, soft cloth. 

- Connect mains plug of this model to a mains socket outlet with a protective earthing connection. 

⚠ CAUTION

- The unit should be located so that its location or position does not interfere with its proper ventilation. 

- Always grasp only the plug on the power-supply cord when plugging into, or unplugging from, an outlet or this unit. 

- At regular intervals, you should unplug the power plug and clean it by using a dry cloth to wipe all dust and other accumulations away from its prongs. Also, disconnect the power plug from the power outlet whenever the unit is to remain unused for an extended period of time. Any accumulation of dust between the power plug and the power outlet can result in poor insulation and lead to fire. 

- Try to prevent cords and cables from becoming entangled. Also, all cords and cables should be placed so they are out of the reach of children. 

- Never climb on top of, nor place heavy objects on the unit. 

⚠ CAUTION

- Never handle the power cord or its plugs with wet hands when plugging into, or unplugging from, an outlet or this unit. 

- If you need to move the instrument, take note of the precautions listed below. At least two persons are required to safely lift and move the unit. It should be handled carefully, all the while keeping it level. Make sure to have a firm grip, to protect yourself from injury and the instrument from damage. 

 - Check to make sure the knob bolt securing the unit to the stand have not become loose. Fasten them again securely whenever you notice any loosening.
 - Disconnect the power cord.
 - Disconnect all cords coming from external devices.
 - Raise the adjusters on the stand (p. 12).
 - Close the lid.
 - Remove the music rest.

- Before cleaning the unit, turn off the power and unplug the power cord from the outlet (p. 10). 

- Whenever you suspect the possibility of lightning in your area, pull the plug on the power cord out of the outlet. 

- Be careful when opening/closing the lid so you do not get your fingers pinched (p. 10). Adult supervision is recommended whenever small children use the unit. 

- Keep the included the music rest's attachment screws, screws of stand, and wing nut in a safe place out of children's reach, so there is no chance of them being swallowed accidentally. 

IMPORTANT NOTES

In addition to the items listed under “IMPORTANT SAFETY INSTRUCTIONS” and “USING THE UNIT SAFELY” on pages 2, 3 and 4, please read and observe the following:

Power Supply

- Do not connect this unit to same electrical outlet that is being used by an electrical appliance that is controlled by an inverter (such as a refrigerator, washing machine, microwave oven, or air conditioner), or that contains a motor. Depending on the way in which the electrical appliance is used, power supply noise may cause this unit to malfunction or may produce audible noise. If it is not practical to use a separate electrical outlet, connect a power supply noise filter between this unit and the electrical outlet.
- Before connecting this unit to other devices, turn off the power to all units. This will help prevent malfunctions and/or damage to speakers or other devices.
- Although the LCD and LEDs are switched off when the POWER switch is switched off, this does not mean that the unit has been completely disconnected from the source of power. If you need to turn off the power completely, first turn off the POWER switch, then unplug the power cord from the power outlet. For this reason, the outlet into which you choose to connect the power cord’s plug should be one that is within easy reach.

Placement

- Using the unit near power amplifiers (or other equipment containing large power transformers) may induce hum. To alleviate the problem, change the orientation of this unit; or move it farther away from the source of interference.
- This device may interfere with radio and television reception. Do not use this device in the vicinity of such receivers.
- Noise may be produced if wireless communications devices, such as cell phones, are operated in the vicinity of this unit. Such noise could occur when receiving or initiating a call, or while conversing. Should you experience such problems, you should relocate such wireless devices so they are at a greater distance from this unit, or switch them off.
- Do not expose the unit to direct sunlight, place it near devices that radiate heat, leave it inside an enclosed vehicle, or otherwise subject it to temperature extremes. Also, do not allow lighting devices that normally are used while their light source is very close to the unit (such as a piano light), or powerful spotlights to shine upon the same area of the unit for extended periods of time. Excessive heat can deform or discolor the unit.

- When moved from one location to another where the temperature and/or humidity is very different, water droplets (condensation) may form inside the unit. Damage or malfunction may result if you attempt to use the unit in this condition. Therefore, before using the unit, you must allow it to stand for several hours, until the condensation has completely evaporated.
- Do not allow rubber, vinyl, or similar materials to remain on the unit for long periods of time. Such objects can discolor or otherwise harmfully affect the finish.
- Do not allow objects to remain on top of the keyboard. This can be the cause of malfunction, such as keys ceasing to produce sound.
- Do not paste stickers, decals, or the like to this instrument. Peeling such matter off the instrument may damage the exterior finish.

Maintenance

- To clean the unit, use a dry, soft cloth; or one that is slightly dampened. Try to wipe the entire surface using an equal amount of strength, moving the cloth along with the grain of the wood. Rubbing too hard in the same area can damage the finish.
- Never use benzine, thinners, alcohol or solvents of any kind, to avoid the possibility of discoloration and/or deformation.
- The pedals of this unit are made of brass. Brass eventually darkens as the result of the natural oxidization process. If the brass becomes tarnished, polish it using commercially available metal polisher.

For HP103-PE

- Since your piano has a polished finish that is as delicate as that found on finely crafted wooden furniture, it needs careful, periodic care. A few important suggestions concerning the proper care of the unit follow.
 - **For dusting, wipe the instrument with a soft cloth that has been soaked with water, then squeezed dry.** Be sure to wipe gently. Even the tiniest grains of sand or grit can leave scratches on the surface if too much force is applied while wiping. Do not use any cleaners or detergents, since they might deteriorate the surface of the cabinet, and produce cracks. Do not use dusting cloths that contain chemicals.

IMPORTANT NOTES

Additional Precautions

- Use a reasonable amount of care when using the unit's buttons, sliders, or other controls; and when using its jacks and connectors. Rough handling can lead to malfunctions.
- When connecting / disconnecting all cables, grasp the connector itself—never pull on the cable. This way you will avoid causing shorts, or damage to the cable's internal elements.
- A small amount of heat will radiate from the unit during normal operation.
- To avoid disturbing your neighbors, try to keep the unit's volume at reasonable levels. You may prefer to use headphones, so you do not need to be concerned about those around you (especially when it is late at night).
- When you need to transport the unit, pack it in shock-absorbent material. Transporting the unit without doing so can cause it to become scratched or damaged, and could lead to malfunction.
- Do not apply undue force to the music rest while it is in use.
- Use a cable from Roland to make the connection. If using some other make of connection cable, please note the following precautions.
 - Some connection cables contain resistors. Do not use cables that incorporate resistors for connecting to this unit. The use of such cables can cause the sound level to be extremely low, or impossible to hear. For information on cable specifications, contact the manufacturer of the cable.
- Before opening or closing the keyboard lid, always make sure that no pets or other small animals are located on top of the instrument (in particular, they should be kept away from the keyboard and its lid). Otherwise, due to the structural design of this instrument, small pets or other animals could end up getting trapped inside it. If such a situation is encountered, you must immediately switch off the power and disconnect the power cord from the outlet. You should then consult with the retailer from whom the instrument was purchased, or contact the nearest Roland Service Center.

Contents

USING THE UNIT SAFELY3

IMPORTANT NOTES5

Panel Descriptions8

Front Panel.....	8
Rear Panel.....	9

Before You Start Playing10

Connecting the Pedal Cord.....	10
Connecting the Power Cord.....	10
Opening/Closing the Lid.....	10
Setting Up the Music Rest.....	10
Using the Music Holders.....	11
Connecting Headphones.....	11
Using the Headphones Hook.....	11
Turning the Power On and Off.....	11
Adjusting the Sound's Volume and Brilliance.....	12
About the Pedals.....	12
About the Adjuster.....	12

Chapter 1.

Enjoying the Internal Songs and Demo13

Listening to Internal Songs.....	13
Playing Back All Songs Continuously (All Song Play).....	13
Selecting a Song and Playing It.....	13
Listening to the Demo Songs.....	14
Playing Back the Tone Demo Songs.....	14
Listening to a Demo of the Functions.....	15

Chapter 2. Performance.....16

Performing with a Variety of Sounds.....	16
Adjusting the Keyboard Touch (Key Touch).....	17
Adding a Sense of Depth to the Sound (Grand Space).....	18
Adding the Right Sense of Depth for Headphones (Grand Space).....	19
Adding Liveliness to the Sound (Dynamic Emphasis).....	20
Applying Effects to the Sound.....	21
Adding Reverberation to the Sound (Reverb).....	21
Changing the depth of the reverb effect.....	21
Transposing the Key of the Keyboard (Transpose).....	22
Playing Two Sounds Together (Dual Play).....	23
Adjusting the Volume Balance in Dual Play (Dual Balance).....	23
Playing Different Tones with the Left and Right Hands (Split Play).....	24
Changing the Keyboard's Split Point.....	25
Using Metronome.....	25
Sounding the Metronome.....	25
Changing the Metronome Volume.....	26
Splitting the Keyboard Into Two Sections for Four-Hand Performances (Twin Piano Mode).....	27

Chapter 3.

Playing Along with the Internal Songs..... 28

Changing the Tempo.....	28
Adding a Count-in to Match the Timing (Count-In).....	28
Playing Each Hand Separately.....	29

Chapter 4. Recording Your Performance..... 30

Notes Regarding Recording.....	30
Recording a New Song.....	31
Recording Along with a Song.....	32
Selecting and Recording the Track for Each Hand Separately.....	33
Erasing Recorded Performances.....	34
Erasing a Performance from the Specified Track.....	34
Erasing a Song.....	34

Chapter 5. Changing Various Settings..... 35

Changing the Damper Pedal's Resonance.....	35
Making Detailed Settings (Function).....	35
Tuning to Other Instruments' Pitches (Master Tuning).....	36
Changing the Temperament.....	36
Setting the Tuning Curve (Stretch Tuning).....	37
Applying the Damper Pedal to the Left-hand Keyboard Area.....	37
Changing How Grand Space is Applied (Grand Space Mode).....	37
Preventing the Settings from Changing During Performance.....	38
Disabling Everything Except Piano Play (Panel Lock).....	38
Disabling the Buttons When Using a Tone Other Than Piano (Tone Lock).....	38
Using the V-LINK function.....	38

Chapter 6. Connecting External Devices 39

Connecting to Audio Equipment.....	39
Connecting to a Computer.....	39
Connecting MIDI Devices.....	40
What's MIDI?.....	40
Making MIDI-related Settings.....	40
MIDI Send Channel Settings.....	41
Switching Local Control on and Off.....	41
Transmitting a Performance You Recorded.....	41
Troubleshooting.....	42

Appendices 42

Error Messages/Other Messages.....	43
Tone List.....	44
Internal Song List.....	45
Easy Operation List.....	47
Main Specifications.....	49

Index 50

Panel Descriptions

Front Panel

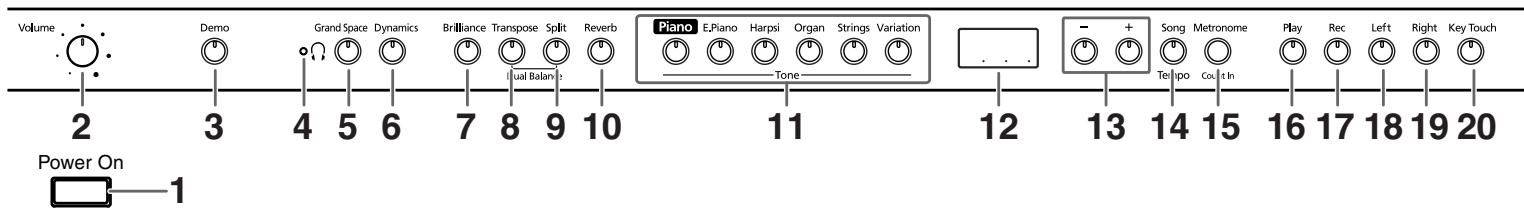

1 [Power On] switch

Turns the power on/off (p. 11).

2 [Volume] knob

Adjusts the overall volume level (p. 12).

3 [Demo] button

You can listen to a demo of the instrument's tones as well as a demo of the various functions (p. 14).

4 [(Headphones)] indicator

This indicator lights up when headphones are connected to the headphone jack (p. 11).

5 [Grand Space] button

Adds a sense of depth to the sound (p. 18, p. 19).

6 [Dynamics] button

You can add liveliness to the sound to give it superb clarity and distinctness (p. 20).

7 [Brilliance] button

Adjusts the tone brightness (p. 12).

8 [Transpose] button

Transposes the pitch of the keyboard (p. 22).

9 [Split] button

Divides the keyboard into right-hand and left-hand areas, allowing you to play a different sound in each area (p. 24). By holding down this button and the [Reverb] button, and pressing other specified button, you can make settings for various functions (p. 35–p. 38, p. 40–p. 41).

10 [Reverb] button

Adds reverberation to the sound (p. 21).

11 Tone buttons

They are used to choose the kinds of tones (tone groups) played by the keyboard (p. 16).

12 Display

The display indicates values for various settings, including the tone variation, song number, and tempo. Usually these will appear as in the figure above.

13 [-] [+] buttons

Allow you to select the value of various settings.

Pressing both the [-] and [+] buttons simultaneously returns the setting of a particular item or function to its original value.

14 [Song/Tempo] Button

Used to select from the internal songs (p. 13, p. 28).

Each time you press this button, the song number and the tempo will be displayed alternately.

While the song number is displayed, the button indicator will light in red. While the tempo is displayed, it will light in green.

15 [Metronome/Count In] Button

Turns the metronome on/off (p. 25). Also featured is the count-in sound, which can be played before the song starts, allowing you to begin playing with the song with perfect timing (p. 28).

16 [Play] button

Starts and stops playback of internal songs and recorded performances (p. 13, p. 28).

Also starts/stops recording of a performance (p. 31–p. 33).

17 [Rec] button

Puts the HP103 in recording-standby mode (p. 30–p. 34).

18 [Left] button

Plays back or records a performance separately for each hand (p. 29, p. 32–p. 34).

The left-hand performances of the internal songs are assigned to this button.

This button and the following [Right] button are collectively referred to as the "track buttons."

19 [Right] button

Plays back or records a performance separately for each hand (p. 29, p. 32–p. 34).

The right-hand performances of the internal songs are assigned to this button.

20 [Key Touch] button

Modifies the playing feel of the keyboard (p. 17).

Rear Panel

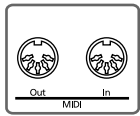

1

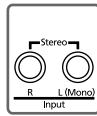

2

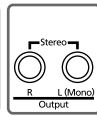

3

1 MIDI Out/In connectors

Connect to external MIDI devices to exchange performance data (p. 40).

2 Input jacks

These jacks can be connected to another sound generating device or an audio device, so that the sound of that device will be output from the HP103's speakers (p. 39).

3 Output jacks

Allows you to output the piano's sound to sound reinforcement equipment to obtain a more powerful sound. These can also be connected to a tape recorder or other recording device to record a performance (p. 39).

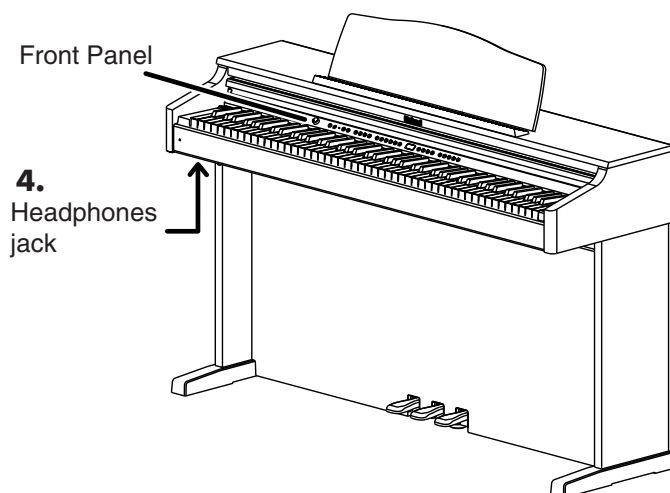

4 Headphones jacks

A set of headphones can be connected here (p. 11).

5 Pedal jack

Connect the pedal cable of the special stand to this jack (p. 10).

6 AC inlet

Connect the supplied power cord here.

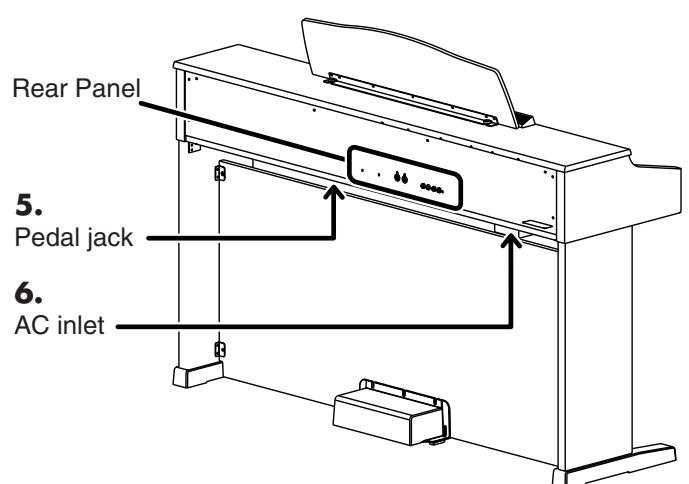

Before You Start Playing

Connecting the Pedal Cord

Connect the pedal cord to the Pedal jack on the bottom panel of the instrument, at the rear.

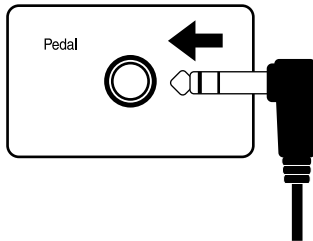

Connecting the Power Cord

1. Insert the included power cord into the AC inlet on the bottom panel of the instrument, at the rear.
2. Plug the power cord into a power outlet.

NOTE

Be sure to use the supplied power cord.

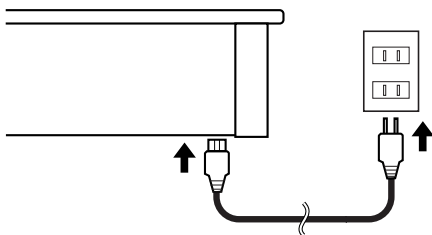

Opening/Closing the Lid

To open the lid, use both hands to lift it lightly, and slide it away from yourself.

To close the lid, pull it gently toward yourself, and lower it softly after it has been fully extended.

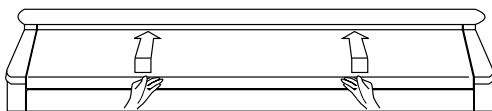

NOTE

When opening and closing the lid, be careful not to let your fingers get caught. If small children will be using the HP103, adult supervision should be provided.

NOTE

If you need to move the piano, make sure the lid is closed first to prevent accidents.

Setting Up the Music Rest

1. Insert the included music rest attachment screws into the screw holes on top of the HP103, and tighten the screws slightly.

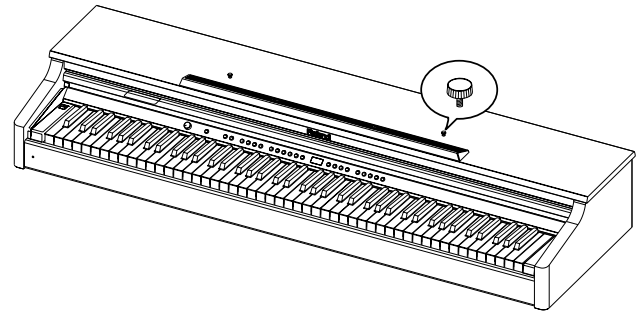

2. Put the music rest between the screws and the HP103's body.

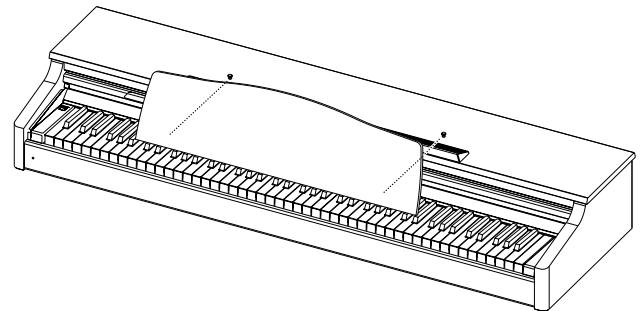

3. While supporting the music rest with one hand, secure it in place by turning the screws.

When attaching the music rest, support it firmly with one hand to make sure that you don't drop it. Be careful, so you don't get your fingers pinched.

4. To remove the music rest, support it with one hand while loosening the screws.

After removing the music rest, don't forget to retighten the screws.

NOTE

Do not apply excessive force to the installed music rest.

NOTE

Be sure to use the supplied screws for attaching the music rest.

NOTE

Before moving the piano, be sure to remove the music rest to prevent accidents.

■ Using the Music Holders

You can use the holders to hold pages in place. When not using the holders, leave them folded down.

* HP103-PE has not music holders.

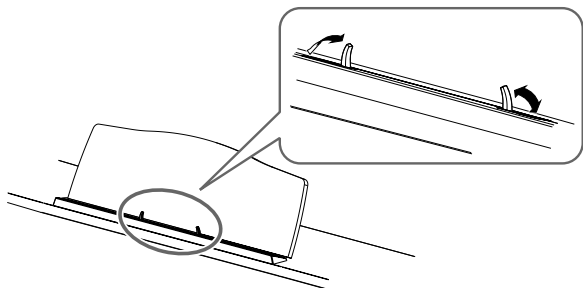

Connecting Headphones

The HP103 has two jacks for plugging in headphones. This allows two people to listen through headphones simultaneously, making it very useful for lessons and when performing piano pieces for four hands. Additionally, this allows you to play without having to worry about bothering others around you, even at night.

Plug the headphones into the Phones jack located at the bottom left of the piano.

When headphones are connected, the  (Headphones) indicator (p. 8) lights up, and sounds stop playing from the speakers of the HP103.

The headphone volume is adjusted by the [Volume] knob (p. 12) of the HP103.

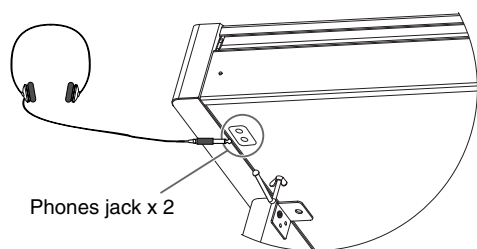

NOTE

Use Stereo headphones.

Some notes on using headphones

- To prevent damage to the cord, handle the headphones only by the headset or the plug.
- Connecting the headphones when the volume of connected equipment is turned up may result in damage to the headphones. Lower the volume on the HP103 before plugging in the headphones.
- Listening at excessively high volume levels will not only damage the headphones, but may also cause hearing loss. Use the headphones at a moderate volume level.

■ Using the Headphones Hook

Whenever you are not using the headphones, you can hang them on the headphone hook at the lower left of the HP103.

Attaching the Headphone Hook

Press and twist the headphone hook included with the HP103 into the hole in the bottom of the HP103 (refer to the figure below). Turn the wing nut of headphone hook to secure the headphone hook.

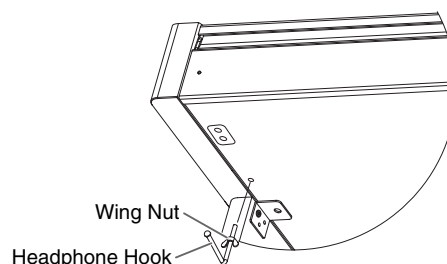

Turning the Power On and Off

NOTE

Once the connections have been completed, turn on power to your various devices in the order specified. By turning on devices in the wrong order, you risk causing malfunction and/or damage to speakers and other devices.

To turn the power on, turn the [Volume] knob all the way down, and then press the [Power On] switch.

The power will turn on, and the Power indicator at the left front of the HP103 will light.

After a few seconds, you will be able to play the keyboard to produce sound.

Use the [Volume] knob to adjust the volume.

* This unit is equipped with a protection circuit. A brief interval (a few seconds) after power up is required before the unit will operate normally.

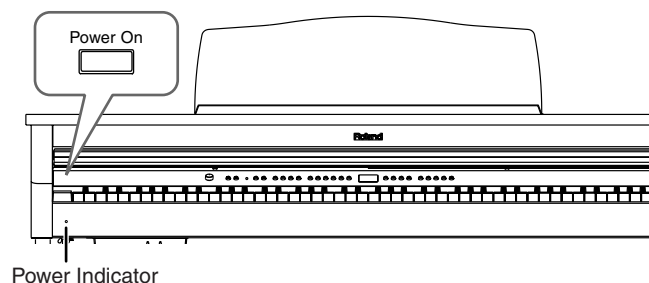

To turn the power off, turn the [Volume] knob all the way to the left, and press the [Power On] switch.

The Power indicator at the left front of the HP103 will go dark, and the power will be turned off.

* If you need to turn off the power completely, first turn off the [POWER] switch, then unplug the power cord from the power outlet. Refer to "Power Supply" (p. 5).

Before You Start Playing

Adjusting the Sound's Volume and Brilliance

Turn the [Volume] knob to adjust the overall volume.

Press the [Brilliance] button to adjust the brightness of the sound.

Select one of the three available settings to obtain the desired brilliance.

[Brilliance] button's indicator	Off	Lit in red	Lit in green
Brilliance	Medium	Mellow	Bright

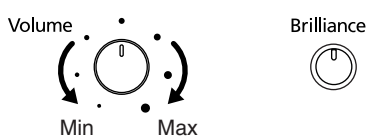

About the Pedals

The pedals have the following functions, and are used mainly for piano performance.

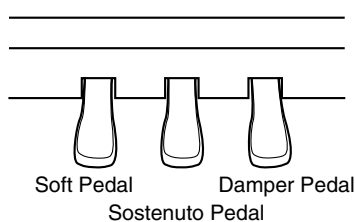

Damper pedal (right pedal)

While this pedal is pressed, notes will be sustained even after you take your fingers off the keys.

On an acoustic piano, holding down the damper pedal will allow the remaining strings to resonate in sympathy with the sounds that you played from the keyboard, adding a rich resonance.

The HP103 simulates this damper resonance.



You can change the amount of resonance applied with the damper pedal. Please refer to "Changing the Damper Pedal's Resonance" (p. 35).

Sostenuto pedal (center pedal)

This pedal sustains only the sounds of the keys that were already played when you pressed the pedal.

Soft pedal (left pedal)

When you hold down this pedal and play the keyboard, the sound will have a softer tone.

About the Adjuster

When you move the HP103 or if you feel that the pedals are unstable, adjust the adjuster located below the pedals as follows.

- Rotate the adjuster to lower it so that it is in firm contact with the floor. If there is a gap between the pedals and the floor, the pedals may be damaged. In particular when placing the instrument on carpet, adjust this so that the pedals firmly contact the floor.

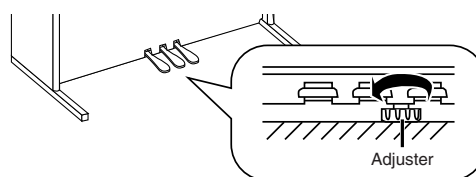

If the adjuster is difficult to turn, have one person lift either the left or right side of the stand to make it easier for another person to turn the adjuster and make the adjustment.



After adjusting the adjuster, press the pedals, and if the front board moves, turn the adjuster further so that it makes firm contact with the floor.



Always readjust the adjuster after moving the piano.

Chapter 1. Enjoying the Internal Songs and Demo

Listening to Internal Songs

The HP103 comes with 66 piano songs onboard.

■ Playing Back All Songs Continuously (All Song Play)

The internal songs can be played back consecutively.



“Chapter 3. Playing Along with the Internal Songs” (p. 28)

“Internal Song List” (p. 45)

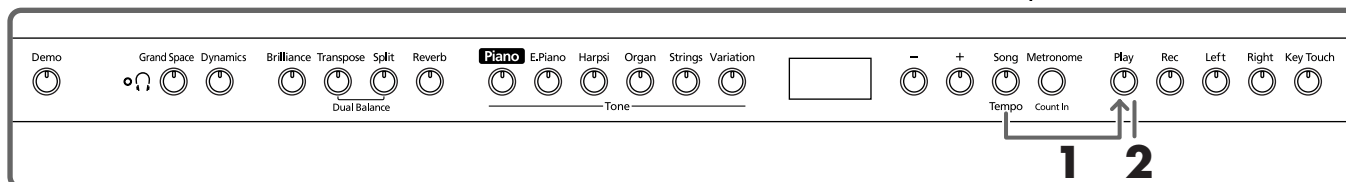

1 Hold down the [Song/Tempo] button, and press the [Play] button.

The [Song/Tempo] button's indicator will light in red, the [Play] button's indicator will blink, and the songs will play back successively, starting with the currently selected song.

The song number appears in the display for several seconds.



You can press the [-] or [+] button to select the song that you want to play back. When all songs have been played, playback will return to the first song and resume.

Stopping the playback

2 Press the [Play] button.

Playback will stop.

■ Selecting a Song and Playing It

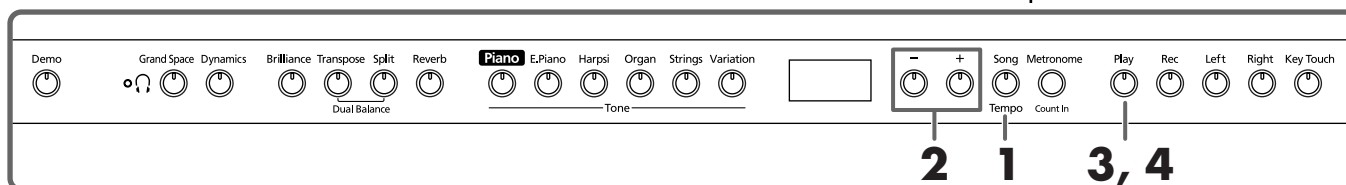

Choosing the song to play back

1 Press the [Song/Tempo] button, getting its indicator to light in red.

The song number appears in the display for several seconds.



2 Press the [-] or [+] button to select a song.

Holding down the button causes the numbers to change continuously.

Playing back

3 Press the [Play] button.

The button's indicator will light, and the selected song will play.



When you play back an internal song, the reverb effect will automatically be turned on (the button's indicator lights).



About the display for the internal songs

USr (user) ... The location where you can record your performance. (For details on recording → p. 31)

Numbers with a “S.”

... internal songs.

Chapter 1. Enjoying the Internal Songs and Demo

Stopping the playback

4 Press the [Play] button.

The button's indicator goes out, and playback stops.

The next time you press the [Play] button, the song that was stopped is played from the beginning.

Listening to the Demo Songs

You can listen to various demo songs, including those demonstrating the piano and other tones, as well as the function applied to the piano tones.

■ Playing Back the Tone Demo Songs

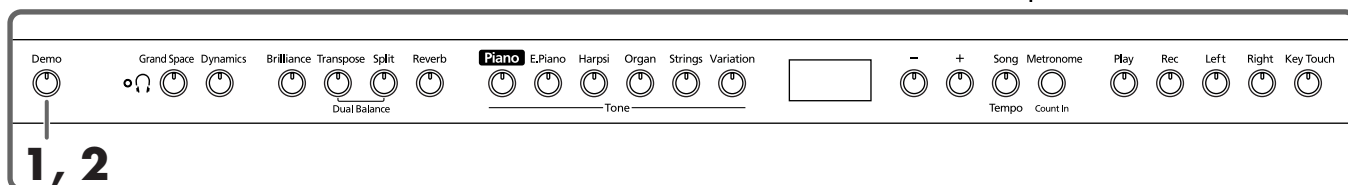

1 Press the [Demo] button.

The button's indicator flashes, and playback of the tone demo songs starts.



When playback of the last song is finished, playback then returns to the first song.

When you press any of the tone buttons while the [Demo] button is flashing, the demo song corresponding to that tone button is played.

Button assigned tone demo	Demo content
[Piano]	Piano tone demo songs
[E. Piano]	E. Piano tone demo songs
[Harpsi]	Harpsichord tone demo songs
[Organ]	Organ tone demo songs
[Strings]	Strings tone demo songs
[Split]	Demo songs using the Split function (p. 24)

Stopping the Tone Demo Songs

2 Press the [Demo] button.

The [Demo] button's indicator goes off, and the demo quits.

■ Listening to a Demo of the Functions

You can listen to the demo of the functions that can be applied to the piano tones.

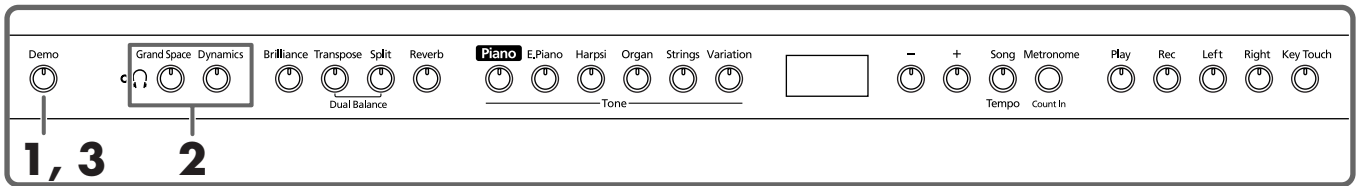

1 Press the [Demo] button.

The button's indicator flashes, and playback of the tone demo songs starts.

2 Press any of the following buttons.

Button assigned function demo	Demo content	Page
[Grand Space]	Grand Space demo	p. 18 p. 19
[Dynamics]	Dynamic Emphasis demo	p. 20

When a button is pressed, the demo assigned to the button is played. Two versions of the demo will be played—one includes the function provided by the button you've pressed, the other doesn't.



Stopping the Demo of the Functions

3 Press the [Demo] button.

The [Demo] button's indicator goes off, and the demo quits.



When you press the button pressed in Step 2, you can switch between demos both with the function switched on and off.

Chapter 2. Performance

Performing with a Variety of Sounds

The HP103 contains 20 different internal tones. The tones are organized into five tone groups, which are assigned to the Tone buttons.

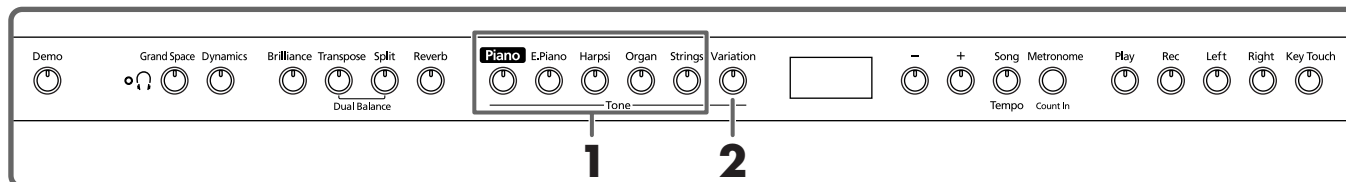

Selecting a tone group

1 Press any Tone button.

The indicator of the button you pressed will light.

When you play the keyboard, you will hear a sound in the selected tone group.

Selecting variation tones

2 Press the [Variation] button.

Four different tones (numbered 1–4) are assigned to each Tone button. Use the [Variation] button to select among them.

Each time you press the [Variation] button, the button's indicator will change color, and the four sounds will be selected successively.

Tone number	1	2	3	4
[Variation] button's indicator	Dark	Red	Green	Orange

Some of the number 3 and 4 tones form pairs, which can be layered and sounded together.

The tone you've selected is heard when you finger the keyboard.



For more details, refer to "Tone List" (p. 44).



When Dual play (p. 23) or Split play (p. 24) is used, only sound number 1 or 2 can be selected. If you use Dual play or Split play with a Tone button for which tone number 3 or 4 is selected, tone number 1 will be selected for that Tone button.

Adjusting the Keyboard Touch (Key Touch)

You can adjust the touch (playing feel) of the keyboard.

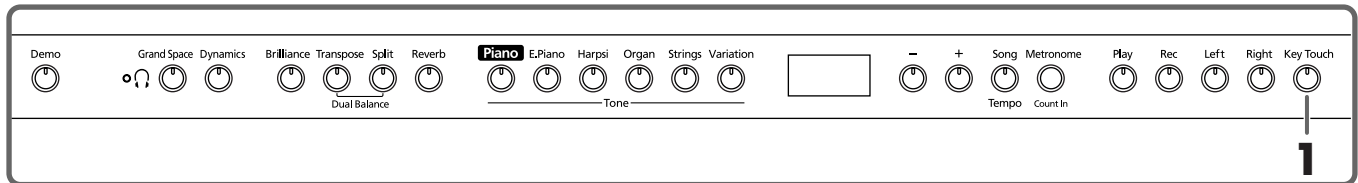

1 Press the [Key Touch] button.

The button's indicator will light, and the feel of the keyboard will change.

Each time you press the [Key Touch] button, the button's indicator will change color, and the feel of the keyboard will change.

Indicator	Settings	
OFF	Medium	This allows you to play using the most natural touch. This is the closest to the touch of an acoustic piano.
Red	Heavy	Fortissimo (ff) cannot be produced unless you play more strongly than usual, making the keyboard feel heavier. Dynamic fingering adds even more feeling to what you play.
Green	Light	Fortissimo (ff) can be produced by playing less strongly than usual, making the keyboard feel lighter. This setting makes it easy to play, even for children.
Orange	Fixed	Sounds at a fixed volume, regardless of your keyboard playing strength.

Adding a Sense of Depth to the Sound (Grand Space)

The HP103 includes a “Grand Space” function that allows you to get sounds that have a sense of depth like you get by playing an acoustic grand piano. Using this function gives you the natural-sounding reverberation and depth of sound that an acoustic grand piano provides.

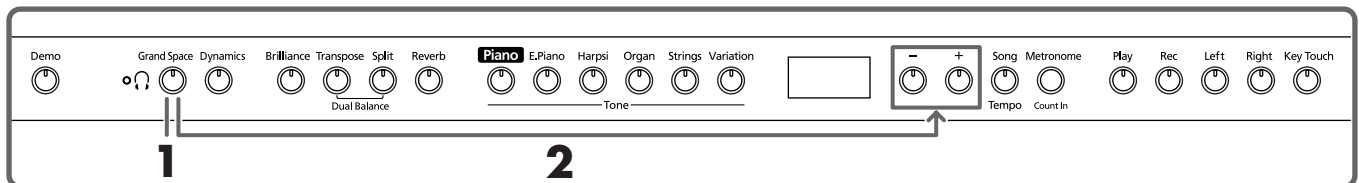

1 Press the [Grand Space] button, getting its indicator to light.

The Grand Space function is switched on, giving the sound a greater sense of depth.

To cancel the Grand Space function, press the [Grand Space] button once more so its illumination is turned off.

Changing the Grand Space Settings

2 Hold down the [Grand Space] button, and press the [-] or [+] button.

You can adjust the sense of depth to any of four levels.

A greater sense of depth is produced as the value is increased.



MEMO

When Grand Space Mode (p. 37) is set to “1” and a pair of headphones is connected, the sense of depth is optimized for headphones, and when no headphones are connected, the optimal depth for speakers is selected.

Adding the Right Sense of Depth for Headphones (Grand Space)

You can achieve the kind of sonic depth produced with a grand piano through headphones as well. This feature creates an ambience that makes it seem you are seated in front of a grand piano as you perform.

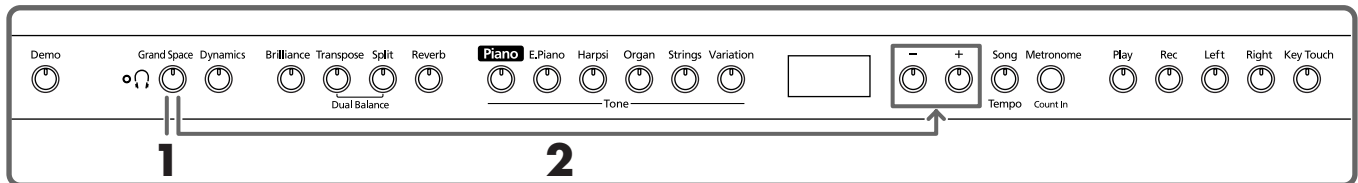

1 Press the [Grand Space] button, getting its indicator to light.

The Grand Space function is switched on, giving the sound a greater sense of depth.

To cancel the Grand Space function, press the [Grand Space] button once more so its illumination is turned off.

Changing the Grand Space Settings

2 Hold down the [Grand Space] button, and press the [-] or [+] button.

You can adjust the sense of depth to any of four levels.

A greater sense of depth is produced as the value is increased.



MEMO

When Grand Space Mode (p. 37) is set to “1” and a pair of headphones is connected, the sense of depth is optimized for headphones, and when no headphones are connected, the optimal depth for speakers is selected.

MEMO

The [(Headphones)] indicator lights up when headphones are connected.

Adding Liveliness to the Sound (Dynamic Emphasis)

You can add liveliness to the sound to give it superb clarity and distinctness.

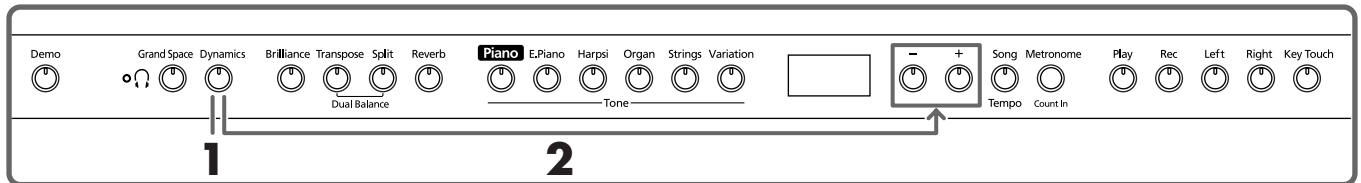

1 Press the [Dynamics] button, getting its indicator to light.

The Dynamic Emphasis function is switched on, enlivening the sound.

To cancel the Dynamic Emphasis function, press the [Dynamics] button once more so its illumination is turned off.

Changing the Dynamic Emphasis Settings

2 Hold down the [Dynamics] button, and press the [-] or [+] button.



Display	Description
1	Creates a sound with boosted bass and treble.
2	Produces a sound with chords in the low registers that are clear and distinct.
3	Creates a sound with boosted bass.

Applying Effects to the Sound

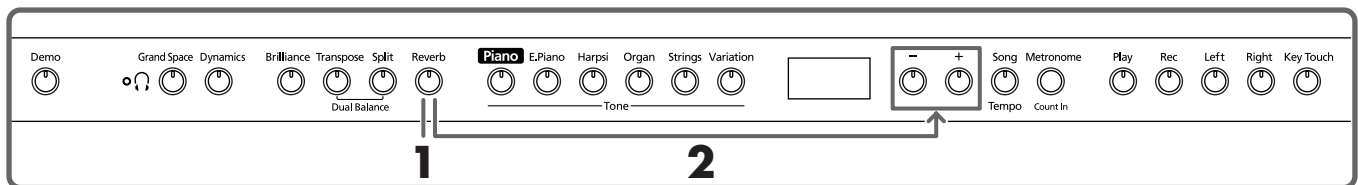

■ Adding Reverberation to the Sound (Reverb)

By applying the reverb effect you can produce a pleasant reverberation, making it sound as though you were performing in a concert hall.

1 Press the [Reverb] button.

The button's indicator will light, and a reverb effect will be applied to the sound.

To cancel the reverb effect, press the [Reverb] button, getting its indicator to go dark.

■ Changing the depth of the reverb effect

The amount (depth) of the reverb effect can be set to any of eight levels.

2 Hold down the [Reverb] button and press the [-] or [+] button.

The currently specified value will be displayed.

Higher values will produce a deeper effect.



When you play back an internal song, the reverb effect will automatically be turned on (the button's indicator lights).



When the power is turned on, reverb is set to "4."



When you hold down the [Reverb] button, the currently specified reverb depth value will be displayed.

Transposing the Key of the Keyboard (Transpose)

By using the “Transpose function,” you can transpose your performance without changing the notes you play. For example, even if the song is in a difficult key with numerous sharps (#) or flats (b), you can transpose it to a key that is easier for you to play.

When accompanying a vocalist, you can easily transpose the pitch to a range that is comfortable for the singer, while still playing the notes as written (i.e., with the same fingering positions).

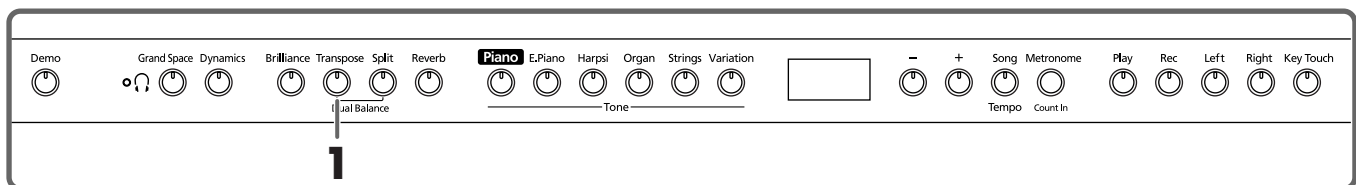

1 Continue to hold down the [Transpose] button, and press a note to indicate the tonic of the key to which you want to transpose.

The button’s indicator will light, and the keyboard will be transposed.

You can also transpose by holding down the [Transpose] button and pressing the [-] or [+] button.

If you hold down the [Transpose] button and press the [-] and [+] buttons simultaneously, the setting will return to the original value (0).

This can be set in a range of -6–0–5 (semitone steps).

For example, if you want the E pitch to sound when you play the C key, hold down the [Transpose] button and press the E key.

Counting from C as a reference point, one moves up four keys, including the black keys, to reach E, thus “4” appears in the display.

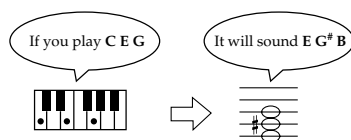

When the transpose value is set to “0,” the button’s indicator will remain dark even if you press the [Transpose] button.

To cancel the transpose function, press the [Transpose] button, extinguishing its indicator.

When you press the [Transpose] button once again, getting its indicator to light, the keyboard will be transposed to the note you specified here.



When you hold down the [Transpose] button, the currently specified value will be displayed.



This setting returns to the original value (0) when you turn off the power.

Playing Two Sounds Together (Dual Play)

Simultaneously playing two tones when one key is pressed is called "Dual play."

1 Simultaneously press the two Tone buttons that you want to play together.

The indicator of the button you pressed will light.

When you play the keyboard, the tones of the two Tone buttons you selected will sound simultaneously.

To cancel Dual play, press any Tone button.

To change the tone of the right button of the two selected tones

Press the [Variation] button.

Dual play now features the tone of the left side's tone button along with the newly selected tone.

To change the tone of the left button of the two selected tones

Cancel the Dual play, and then re-select the tone.

■ Adjusting the Volume Balance in Dual Play (Dual Balance)

You can change the volume balance between the two layered sounds in Dual play.



When Dual play is used, the [Variation] button's indicator will light to indicate the selection of the right button of the two selected tones.



When Dual play is used, only sound number 1 or 2 can be selected.

If you use Dual play with a Tone button for which tone number 3 or 4 is selected, tone number 1 will be selected for that Tone button.

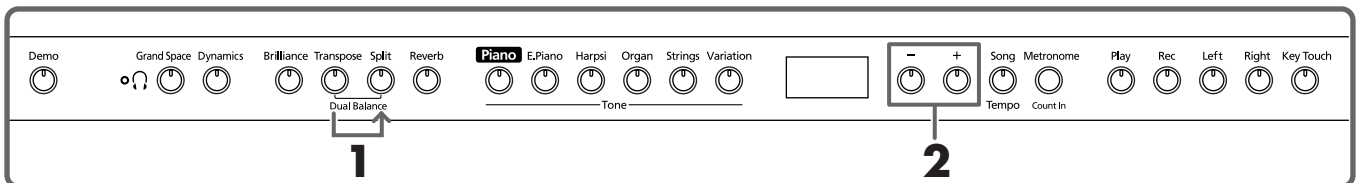

1 Hold down the [Transpose] button and press the [Split] button.

The indicators of the buttons you pressed will blink.

The current volume balance appears in the display.

2 Press the [-] or [+] button to change the value.

The volume balance changes.

To return to the original volume balance, press the [-] and [+] buttons simultaneously.



Volume of the left button tone Volume of the right button tone

Press the [Transpose] or [Split] button, and the button's indicator will return to the previous state.

Playing Different Tones with the Left and Right Hands (Split Play)

Dividing the keyboard into right-hand and left-hand areas, then playing different sounds in each is called “Split play.” The boundary key is called the “split point.”

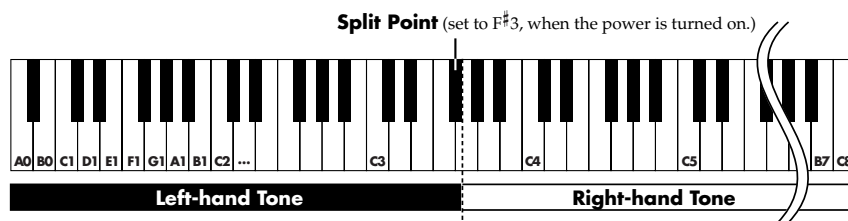

The split point key is included in the left-hand keyboard area.



When Split play is used, only tone numbers 1 or 2 can be selected.

If you use Split play with a Tone button for which tone numbers 3 or 4 selected, tone number 1 will be selected for that Tone button.

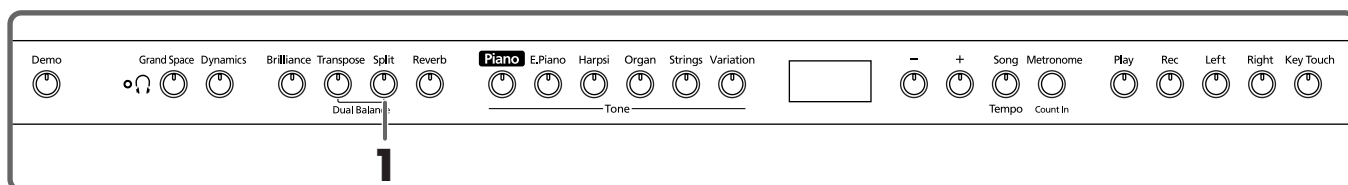

1 Press the [Split] button.

The button’s indicator will light.

The keyboard is divided into right-hand and left-hand areas.

The tone played on the right side is the tone in use before the [Split] button is pressed, while the bass tone is played on the left side.

To cancel Split play, press the [Split] button, getting its indicator to go dark.

Changing tone played by the left hand

Press the [Variation] button.

Each time you press the [Variation] button, the button’s indicator will change color, and the left-hand tone will change.

Some tones assign the tone that had been selected before you pressed the [Split] button to the left hand area of the keyboard.

Changing tone played by the right hand

Press the Tone button.

The tone of the right-hand area will change. A tone that is a suitable match for the right-hand tone will be selected for the left-hand area.

If you want to change the variation for the right-hand tone, cancel Split play and then re-select the tone.



When using Dual play, press the [Split] button

The right hand will play the tone of the left button of Dual play, and the left hand will play a suitable match for the right-hand tone.



For information about the tones that can be selected for the left hand section, refer to the “Tone List” (p. 44).



The selected left hand tone is remembered for each Tone button. When you turn off the power, it will return to the original setting.



In Split play, the damper pedal will be applied only to the right-hand area of the keyboard. If you want the damper pedal to be applied to the left-hand area, refer to “Applying the Damper Pedal to the Left-hand Keyboard Area” (p. 37).

■ Changing the Keyboard's Split Point

You can change the location where the keyboard is divided (the split point) within the range of B1 through B6.

- 1 While continuing to hold the [Split] button, press the key that you want to specify as the split point.

The key you pressed becomes the split point, and belongs to the left-hand section of the keyboard.

You can also change the setting by pressing the [-] or [+] button while continuing to hold down the [Split] button.

If you hold down the [Split] button and simultaneously press the [-] and [+] buttons, the setting will return to its original value (F#3).



Using Metronome

■ Sounding the Metronome

The HP103 features a built-in metronome.

While a song plays back, the metronome will sound at the tempo and time signature (Beat) of that song.



The setting is at "F#3" when the piano is powered up.



The split point key is displayed as follows.

Display	C	C ⁻	d	E ₋
Letter name	C	C#	D	E _b
Display	E	F	F ⁻	G
Letter name	E	F	F#	G
Display	A ₋	A	b ₋	b
Letter name	A _b	A	B _b	B



When you continue holding the [Split] button, the currently specified split point will be displayed.

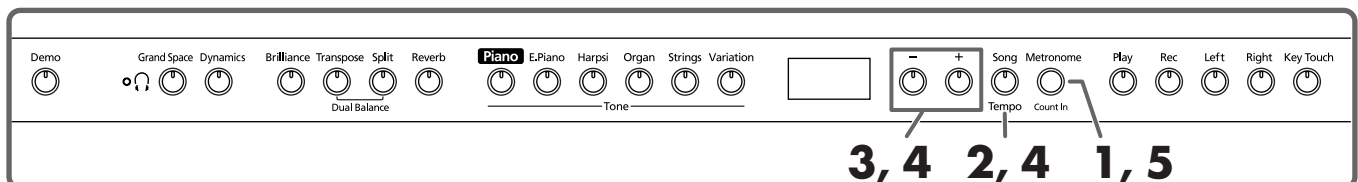

Sounding the metronome

- 1 Press the [Metronome/Count In] button.

The metronome will sound.

The button flashes in red and green in time with the beat selected at that time. The button lights in red on the downbeats, and in green on weak beats.

Changing the tempo

- 2 Press the [Song/Tempo] button; the button's indicator lights in green.
- 3 Press the [-] or [+] button to adjust the tempo.

Chapter 2. Performance

Changing the beat of metronome

4 Hold down the [Song/Tempo] button, and press the [-] or [+] button.

The currently selected beat will be displayed.

If you hold down the [Song/Tempo] button and press the [-] or [+] button, the beat will change.

If you hold down the [Song/Tempo] button and press the [-] and [+] buttons simultaneously, the beat will go back to what it was before you changed it.



Display	beat	Display	beat
2.2	2/2	6.4	6/4
0.4	Only weak beats	7.4	7/4
2.4	2/4	3.8	3/8
3.4	3/4	6.8	6/8
4.4	4/4	9.8	9/8
5.4	5/4	12.8	12/8

Stopping the metronome

5 Once again press the [Metronome/Count In] button, getting the button to go dark.

The metronome will stop.

■ Changing the Metronome Volume

The volume of the metronome can be adjusted, with nine volume levels available.

1 Hold down the [Metronome/Count In] button and press the [-] or [+] button.

The currently specified volume will be displayed.

Continue to hold down the [Metronome/Count In] button, and press the [-] or [+] button to sound the metronome, and change the volume.



NOTE

It is not possible to change the beat during song playback or recording.

MEMO

Correspondence between beat and tempo display

Beat	Tempo Value
2/2	♩ = 10–125
x/4	♩ = 20–250
x/8	♩ = 40–500

MEMO

This is set to “4” when the instrument is turned on.

MEMO

When you hold down the [Metronome/Count In] button, the currently specified metronome volume will be displayed.

NOTE

When the metronome volume is set to “0,” the metronome sound does not play.

Splitting the Keyboard Into Two Sections for Four-Hand Performances (Twin Piano Mode)

You can divide the keyboard into two separate sections, allowing two people to perform in the same registers.

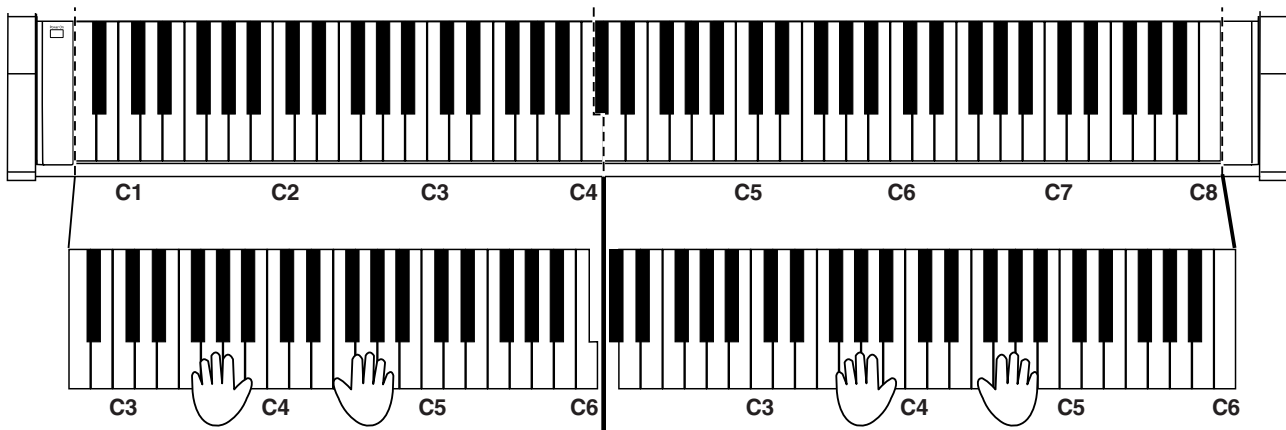

1 While holding down the [Split] button and press the [Piano] button.

The [Split] button's indicator will light, and Twin Piano Mode is switched on.

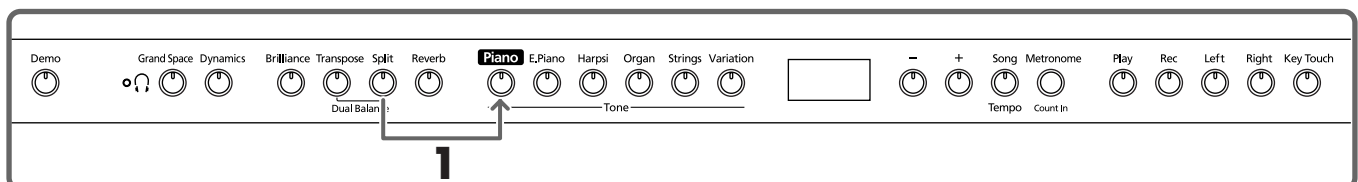

The following occur when Twin Piano Mode is switched on:

- The keyboard is divided into two separate sections, and the pitch changes.
- The right pedal now functions as the damper pedal for the right keyboard section, and the left pedal functions as the damper pedal for the left keyboard section.
- The center pedal now functions as the Sostenuto pedal for the right keyboard section.
- If recording is in progress or the instrument is in recording standby, recording is stopped or recording standby is cancelled. The [Rec] button is disabled while Twin Piano Mode is active.
- If the Split function happens to be on, it is switched off.
- The same tone and effects are used on both the left and right sides. If the piano is in Split Play before switching Twin Piano Mode on, then the tone selected for the right hand in Split Play is used.

* The damper resonance function is not operational in Twin Piano Mode.

2 To exit the function, press the [Split] button.

Chapter 3. Playing Along with the Internal Songs

Here's how you can play along with the internal songs.

You can slow down the playback tempo of the song, or play back each hand separately.

Before you try playing the song, listen to it several times to get a general feel for the song.

For details on operation, refer to "Selecting a Song and Playing It" (p. 13).

Changing the Tempo

If the song has a rapid tempo, you can slow down the tempo so that you can practice it more easily. It is effective to gradually raise the tempo as you practice.



If you turn on the metronome while the song plays back, the metronome will sound at the beat and tempo of the song.



Some of the internal songs have tempos that change during the song.

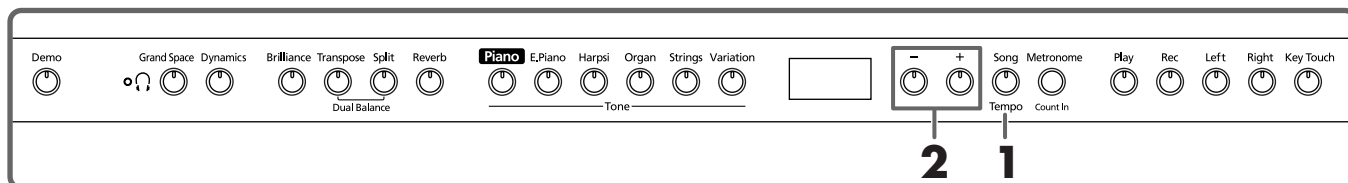

First select the song that you want to play back (p. 13).

1 Press the [Song/Tempo] button, getting its indicator to light in green.

The tempo appears in the display.

Each time you press the [Song/Tempo] button, the tempo and the currently selected song number (prefixed by "S.") will be displayed alternately.

While the tempo is displayed, the [Song/Tempo] button indicator will light in green. While the song number is displayed, it will light in red.

2 Press the [-] or [+] button to adjust the tempo.

The tempo can be adjusted in a range of ♩=20–250.

You can also change the tempo during playback.

Pressing the [+] button once increases the tempo by one unit. Holding down the button increases the tempo continuously.

Pressing the [-] button once decreases the tempo by one unit. Holding down the button makes the tempo change (slow down) continuously.

If you press the [-] and [+] buttons simultaneously, you will return to the basic tempo of the song (the tempo before you modified it).

■ Adding a Count-in to Match the Timing (Count-In)

When you're playing along with a song, you can make sure that your playing is in time with the song by sounding a count before the song starts playing.

Sounding a "count sound" leading up to playback of a song is called "Count-In."

On the HP103, if you playback a song while the metronome is sounding, two measures of lead-in count will be heard at the beginning of the song.



Correspondence between beat and tempo display

Beat	Tempo Value
2/2	♩=10–125
x/4	♩=20–250
x/8	♩=40–500



Indication of the tempo during song playback

While the song is playing, the initial tempo of the song will continue to be displayed, regardless of tempo changes during the song.



About the display for the internal songs

USr (user) ... The location where you can record your performance. (For details on recording → p. 31)

Numbers with a "S." ... internal songs.



During the count-in, the count measure is indicated in the display as "-2" then "-1."



"Sounding the Metronome" (p. 25)

Playing Each Hand Separately

The internal songs allow you to select the performance part that will be played back.

The left-hand performance of the internal songs is assigned to the [Left] button, while the right-hand performance is assigned to the [Right] button. The place where each part of the performance is held is called a “track,” and the [Left] and [Right] buttons are called “track buttons.”

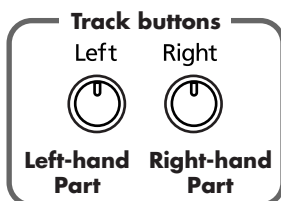

Here’s how to practice each hand separately along with the song.

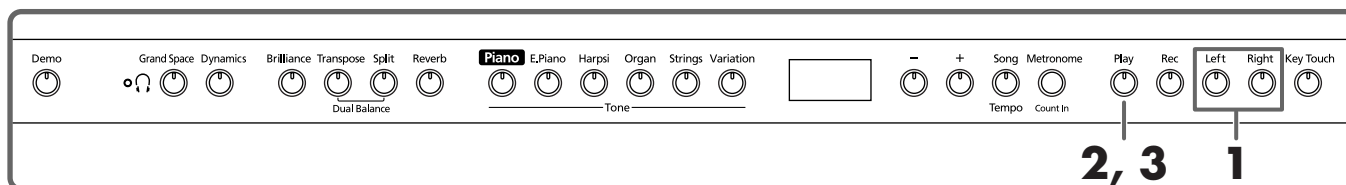

First select the song that you want to play back (p. 13).

Selecting the part that you yourself will play

1 Press the [Left] or [Right] button.

The indicator of the button you’ve pressed goes out, and the sound of the selected part will no longer be heard.

For example, if you want to practice the right hand, press the [Right] button and get its indicator to go dark. When you play back the song, the right-hand performance will not sound.

Playing back a song

2 Press the [Play] button, getting its indicator to light.

The song will begin playing back. The part you selected in step 1 will not sound.

Practice your right-hand performance along with the left-hand playback.

Once again press the button you selected in step 1. The button’s indicator will light, and the sound will be heard once again.

Even while the song is playing, you can press the track buttons to mute or un-mute the sound.

Stopping the song

3 Press the [Play] button.

The song will stop.

Chapter 4. Recording Your Performance

You can easily record your performances.

A recorded performance can be played back to hear your own playing, or to add additional parts.

The following types of recording can be done using the HP103.

- Recording just your own keyboard performance (→ “Recording a New Song” p. 31)
- Recording along with an internal song (→ “Recording Along with a Song” p. 32)
- Recording each hand separately (→ “Selecting and Recording the Track for Each Hand Separately” p. 33)

■ Notes Regarding Recording

- Only one song can be recorded.
- Recorded performances are erased when the power is turned off. If you want to keep your performance, you can either record it on an external audio device, or use an external MIDI device to save the performance data on a floppy disk. For details, refer to “Chapter 6. Connecting External Devices” (p. 39).

If you see the following...

If you attempt to record using a different internal song when a performance has already been recorded, the following will appear, and the indicators of [Rec] and [Play] button will blink.



If it is OK to erase the performance, press the [Rec] button.

If you do not want to erase the performance, press the [Play] button.

Recording a New Song

Record only the keyboard performance without playing along with an internal song.

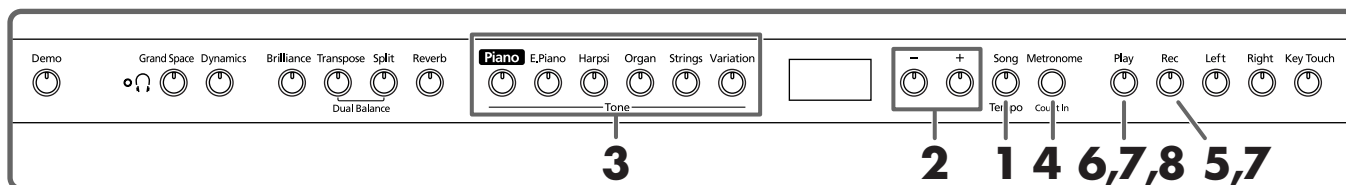

Recording settings (select “USr”)

- 1 Press the [Song/Tempo] button, getting its indicator to light in red.
The song number appears in the display for several seconds.
- 2 Press [-] and [+] buttons simultaneously, and “USr” appears in the display.

Specifying the tone and tempo for recording

- 3 Select the tone that you want to play (p. 16).
- 4 If necessary, turn on the metronome.
Sound the metronome while you set the tempo and beat of the song (p. 25).
- 5 Press the [Rec] button.
The [Rec] button’s indicator will light, the [Play] button’s indicator will blink, and you will be in recording-standby mode.

Start recording

- 6 Recording will start when you either press the [Play] button or play the keyboard.
Two measures of the count sound are played, and the recording begins.
Note that recording will also begin as soon as you play anything on the keyboard, even if you do not press the [Play] button. There is no count sound played when you start in this manner.
When recording begins, the [Play] button and [Rec] button indicators will light.
Go ahead and perform on the keyboard.

Stop recording

- 7 Press the [Play] or [Rec] button.
Recording will stop, and the indicators for the [Play] and [Rec] buttons will go dark.

Play back the recorded performance

- 8 Press the [Play] button.
You will hear the recorded performance.
Once again press the [Play] button, and playback will stop.

NOTE

If you layer a newly recorded performance without erasing the recorded song, the song tempo and beat will be stored with the settings that were recorded first.

MEMO

About the “USr” display

When you stop recording, the “USr” display will change to “USr.”
The “.” in the lower right of the display indicates that there is already a recorded performance.

MEMO

When recording songs that start on an upbeat (that start on a beat other than the first beat of the measure), press the [Rec] button to put the HP103 into recording standby, then press the [Play] button. Two measures of count sound are played, and then recording begins.

MEMO

If you record without specifying the recording track, the performance will be recorded to the [Left] button. If you want to record the right and left hands separately on separate recording tracks, refer to “Selecting and Recording the Track for Each Hand Separately” (p. 33).

Recording Along with a Song

You can record a performance that you play along with an internal song.

Using the [Left] or [Right] buttons, you can perform and record just the right-hand part of a song while listening to the left-hand playback of an internal song.

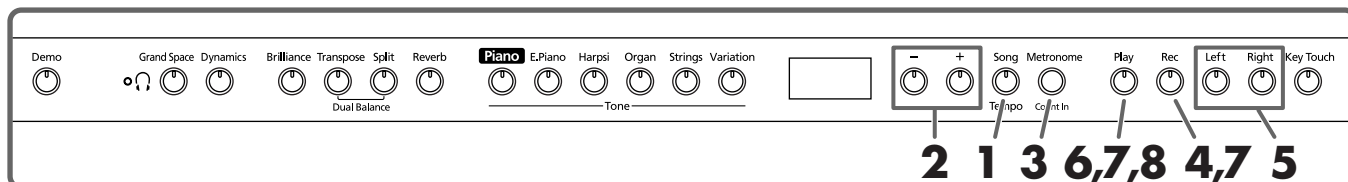

Selecting the song to record

- 1** Press the [Song/Tempo] button, getting its indicator to light in red.

The display will indicate the song number for several seconds.

- 2** Use the [-] or [+] button to select the song that you want to play.

- 3** As necessary, set the metronome and tempo (p. 25).

- 4** Press the [Rec] button.

The [Rec] button's indicator will light.

Selecting the track to record

- 5** Press the [Left] or [Right] button.

When you want to record the left-hand performance, press the [Left] button; to record that of the right hand, press the [Right] button.

The indicators of the button you pressed and of the [Play] button will blink, and the HP103 enters recording-standby mode.

Starting to record

- 6** Press the [Play] button.

Recording begins after two measures of count sound.

Play along with the song.

Stop recording

- 7** Press the [Play] or [Rec] button.

Recording will stop, and the indicators for the [Play] and [Rec] buttons will go dark.

The recorded performance is stored in "USr (User)."

Play back the recorded performance

- 8** Press the [Play] button.

You will hear the recorded performance.

Once again press the [Play] button, and playback will stop.



If "dEL" appears in the display, refer to p. 30.

Selecting and Recording the Track for Each Hand Separately

The recorder of the HP103 has two recording tracks, allowing you to record the right and left hands separately. Use the [Left] button or [Right] button to specify the recording track.

If you want to re-do the recording, you can re-record just a specific track.

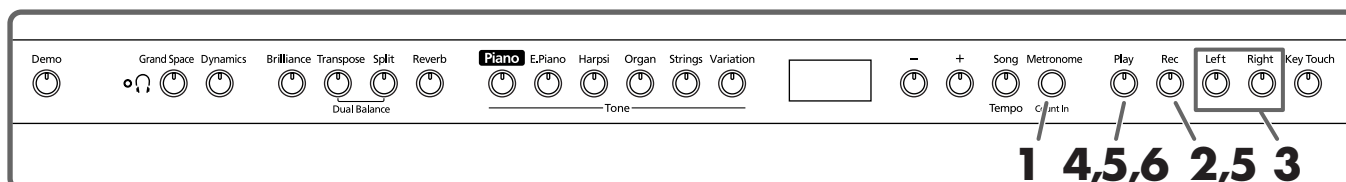

As described in steps **1** and **2** of “Recording a New Song” (p. 31), select “USr” before you continue. When layering recordings with built-in songs, select the built-in song as described in Steps **1** and **2** of “Selecting a Song and Playing It” (p. 13).

1 As necessary, turn on the metronome (p. 25).

2 Press the [Rec] button.

The [Rec] button’s indicator will light.

The button indicators of tracks that are already recorded will light.

The track button for which you will next be recording will be blinking.

Selecting the track to record

3 Press the [Left] or [Right] button to select the track that you want to record.

The indicator of the button you pressed will blink, and the HP103 enters recording-standby mode.

Start recording

4 Press the [Play] button.

Two measures of the count sound are played, and the recording begins. Go ahead and perform on the keyboard.

Note that recording will also begin as soon as you play anything on the keyboard, even if you do not press the [Play] button. There is no count sound played when you start in this manner.

Stop recording

5 Press the [Play] or [Rec] button.

Recording will stop, and the indicators for the [Play] and [Rec] buttons will go dark.

Your performance has been recorded to the specified track button.

If you want to record on the other track, return to step 2 to record your performance again. You can record while you listen to the previously recorded performance.

NOTE

If you go on to record additional material without erasing the recorded song, the song tempo, beat, and metronome settings of the original recording will be used for the new material as well.

MEMO

The track buttons allow you to record to either the [Left] or the [Right] button, one at a time.

Chapter 4. Recording Your Performance

Play back the recorded performance

6 Press the [Play] button.

You will hear the recorded performance.

Press the [Play] button once again, and playback will stop.

Erasing Recorded Performances

You can erase a recorded performance.

■ Erasing a Performance from the Specified Track

You can select a recorded track and erase it.

1 Hold down either the [Left] or [Right] button and press the [Rec] button.

The indicator of the button you pressed will go dark, and the performance of the selected track will be erased.

■ Erasing a Song

You can erase a song you've recorded.

1 Hold down the [Song/Tempo] button and press the [Rec] button.

The following display will appear, and the indicators of the [Rec] and [Play] button will blink.



If you decide not to erase the performance, press the [Play] button.

2 Once again press the [Rec] button.

The recorded performance is erased.

Chapter 5. Changing Various Settings

Changing the Damper Pedal's Resonance

On an acoustic piano, depressing the damper pedal makes the notes you play resonate with other strings, adding rich reverberations and fatness to the sound. The damper pedal on the HP103 recreates this resonance (damper resonance) when depressed.

You can select from eight levels of depth for the resonant sound (resonance level).

This is set to "5" when the instrument is turned on.

* This setting is enabled only with the piano tones. You cannot set this for other tones.

1. Hold down the [Brilliance] button, and press the [-] or [+] button.

The currently specified value will be displayed. Larger values will produce a deeper effect.



Making Detailed Settings (Function)

You can make performance-related settings such as tuning and temperament.

How to enter function mode

1. Hold down the [Split] button, and press the [Reverb] button.

The HP103 switches to the function mode.

The indicators for the [Split] and [Reverb] buttons and the button to which the function is assigned start flashing.









Setting the various functions

2. Press the button to which the desired function is assigned.

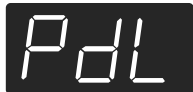
The indicators for pressed button, [Split] button, and [Reverb] button flash.

For details on the contents of each function, refer to the explanations that follow.

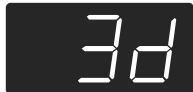
Button	Function	Page
[Piano]	Master Tuning 	p. 36

Button	Function	Page
[E. Piano]	Temperament 	p. 36
[Harpsi]	Stretch Tuning 	p. 37
[Organ]	Applying the damper pedal to the left-hand keyboard area 	p. 37
[Strings]	MIDI send channel 	p. 41
[Variation]	Local Control 	p. 41
[Play]	Transmitting a recorded performance 	p. 41
[Grand Space]	Grand Space Mode 	p. 37
[Right]	V-LINK 	p. 38

For details on each function, refer to the explanations below.

3. Press the [-] or [+] button to change the value.

If you press the [-] and [+] buttons simultaneously, the value will return to the power-up default setting.

How to exit function mode

4. Press the [Split] or [Reverb] button.

The button's indicator will return to the previous state.

Chapter 5. Changing Various Settings

■ Tuning to Other Instruments' Pitches (Master Tuning)

In situations such as when playing ensemble with other instruments, you can tune the HP103's standard pitch to the pitch of another instrument. The standard pitch generally refers to the pitch of the note that's played when you finger the middle A key. This tuning of all the instruments to a standard pitch is called "tuning."

If you press the **[Piano]** button in step 2 of "Making Detailed Settings (Function)" (p. 35), a display like the following will appear.



The last three digits are indicated in the display. "440.0 Hz" is indicated in the figure above.

Value 415.3 Hz–440.0 Hz–466.2 Hz

Power-up default setting 440.0 Hz

This setting remains in effect until you turn off the power.

■ Changing the Temperament

You can play classical styles such as Baroque using historic temperaments (tuning methods).

Today, compositions are generally created with equal temperament in mind and are played using equal temperament. However in past ages of classical music, a variety of temperaments were used. Playing a composition with its original tuning lets you enjoy the sonorities of the chords that the composer originally intended.

If you press the **[E.Piano]** button in step 2 of "Making Detailed Settings (Function)" (p. 35), a display like the following will appear.

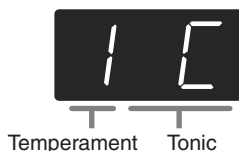

You can choose from among the seven temperaments described below.

Dis-play	Temper-ament	Qualities
1	Equal	In this tuning, each octave is divided into twelve equal steps. Every interval produces about the same amount of slight dissonance. This setting is in effect when you turn on the power.

Dis-play	Temper-ament	Qualities
2	Pythagorean	This tuning, devised by the philosopher Pythagoras, eliminates dissonance in fourths and fifths. Dissonance is produced by third-interval chords, but melodies are euphonious.
3	Just Major	This tuning eliminates ambiguities in the fifths and thirds. It is unsuited to playing melodies and cannot be transposed, but is capable of beautiful sonorities.
4	Just Minor	The Just tunings differ from major and minor keys. You can get the same effect with the minor scale as with the major scale.
5	Mean Tone	This scale makes some compromises in just intonation, enabling transposition to other keys.
6	Werckmeister	This temperament combines the Mean Tone and Pythagorean tunings. Performances are possible in all keys (first technique, III).
7	Kirnberger	This is an improvement of the Mean Tone and Just tunings that provides a high degree of freedom of modulation. Performances are possible in all keys (III).

Power-up default setting 1 C

Tonic

When playing with tuning other than equal temperament, you need to specify the tonic note for tuning the song to be performed (that is, the note that corresponds to C for a major key or to A for a minor key).

While hold down the **[E. Piano]** button, and press a note to specify the desired tonic key.

The tonic note you specify will be displayed as follows.

Display	C	C ⁻	d	E ₋	E	F	F ⁻	G	A ₋	A	b ₋	b
Letter name	C	C [#]	D	E ^b	E	F	F [#]	G	A ^b	A	B ^b	B

If you choose an equal temperament, there's no need to select a tonic note.

- * If you record with a temperament other than equal temperament selected, and then want to play back that performance, use this setting to select the same temperament for playback as the temperament you used when recording.
- * When performing in ensemble with other instruments, be aware that depending on the key, there may be some shifting of the pitch. Tune the HP103 to the fundamental pitch of the other instruments.

■ Setting the Tuning Curve (Stretch Tuning)

A piano is generally tuned to a pitch with a lower bass range and a higher treble range than equal temperament. This special tuning method for pianos is called “Stretch Tuning.”

If you press the **[Harpsi]** button in step 2 of “Making Detailed Settings (Function)” (p. 35), a display like the following will appear.



Display	Descriptions
OFF	This is the standard tuning curve. This is the right choice when using Dual play (p. 23), or when playing in ensemble with other instruments.
On	This tuning curve expands the bass and treble ends somewhat. It is suitable for performances such as piano solos. This setting is in effect when you turn on the power.

Power-up default setting On

→ This effect works only with the piano tones.

■ Applying the Damper Pedal to the Left-hand Keyboard Area

When you are using Split play (p. 24), you can apply the damper pedal effect to the sound played by the left-hand keyboard range.

If you press the **[Organ]** button in step 2 of “Making Detailed Settings (Function)” (p. 35), a display like the following will appear.



Display	Descriptions
On	The damper pedal effect will be applied to the sound of the left and right hand keyboard area.
OFF	The damper pedal effect will not be applied to the sound of the left-hand keyboard area.

Power-up default setting OFF

■ Changing How Grand Space is Applied (Grand Space Mode)

If you press the **[Grand Space]** button in step 2 of “Making Detailed Settings (Function)” (p. 35), a display like the following will appear.



Display	Descriptions
1	When the headphones are connected, the depth effect is optimized for headphones, and when no headphones are connected, the optimal depth for speakers is applied.
2	The optimal depth for speakers is used, regardless of whether or not headphones are connected. Grand Space is also applied to the sound output from the Output jacks, making this convenient when you want to play through speakers connected to the Output jacks.
3	The optimal depth for headphones is used, regardless of whether or not headphones are connected.

Preventing the Settings from Changing During Performance

■ Disabling Everything Except Piano Play (Panel Lock)

The “Panel Lock” function locks the HP103 in a state where only piano performance can be used, and all buttons will be disabled. This prevents the settings from being inadvertently modified even if children press the buttons accidentally.

In the Panel Lock state, only the grand piano sound can be played.

1. Turn the volume to the minimum, and press the [Power On] switch to turn off the power.
2. Hold down the [Piano] button and press the [Power On] switch to turn on the power.

The following display will appear.



All buttons are disabled.

Adjust the volume.

When you play the keyboard, the grand piano sound will be heard.

To defeat the Panel Lock function, turn the volume down to the minimum, and turn on the power once again.

■ Disabling the Buttons When Using a Tone Other Than Piano (Tone Lock)

Even when using Tones other than the Piano, you can set the instrument so all of its buttons are disabled (the settings in effect at that time will be maintained). That way, you won't get switched to the wrong settings if you inadvertently press a few buttons while you're playing.

1. Hold down the [Demo] button and press the [Key Touch] button.

The song or the metronome sound that is playing will stop. The following will appear in the display:



All buttons are disabled while the instrument is set like this. To cancel the Tone Lock function, once again hold down the [Demo] button while you press the [Key Touch] button. Alternatively, you can lower the instrument's volume all the way and switch its power off. Then, turn it on again.

Using the V-LINK function

Connecting the HP103 to a V-LINK compatible image device allows you to control the images with the HP103.

V-LINK

V-LINK (**V-LINK**) is a function that allows music and images to be performed together. By using MIDI to connect two or more V-LINK compatible devices, you can easily enjoy a wide range of visual effects that are linked to the expressive elements of a music performance.

How to Use the V-LINK

1. Hold down the [Split] button, and press the [Reverb] button.

The HP103 switches to the set mode.

2. Press the [Right] button.

The button's indicator flashes.

The following appears in the display.



Display	Descriptions
OFF	The V-LINK function is switched off.
On	The V-LINK function is switched on. You can control images using the twelve keys at the left end of the keyboard.

Power-up default setting OFF

3. Press the [-] and [+] buttons to switch the V-LINK function on and off.

You can control images using the twelve keys at the left end of the keyboard.

While V-LINK is switched on, the following will appear in the display.



* While V-LINK is switched on, no sound is produced when you press any of the twelve keys at the left end of the keyboard.

How to exit function mode

4. Press the [Split] or [Reverb] button.

The button's indicator returns to its original state.

Chapter 6. Connecting External Devices

Connecting to Audio Equipment

You can connect audio devices to play the sound of the HP103 through the speakers of your audio system, or to record your performance on a tape recorder or other recording device.

When connecting, please use an audio cable with a standard phone plug (sold separately).

Connection Examples

- * To prevent malfunction and/or damage to speakers or other devices, always turn down the volume, and turn off the power on all devices before making any connections.

Playing the sound of the HP103 through the speakers of an audio system/Recording the performance of the HP103 on a recording device

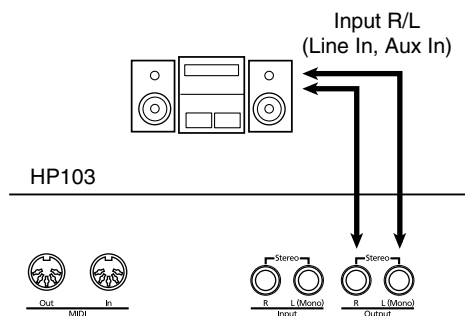

○ Use the following procedure when turning on the power.

1. Turn on the power of the HP103.
2. Turn on the power of the connected device.
3. Adjust the volume of each device.
→ You can adjust the volume of a connected sound module with the HP103.

When Recording HP103 Performances on a Recording Device

4. Start recording with the connected device.
5. Perform on the HP103.
6. When the performance ends, stop recording on the connected equipment.

Playing the sound of an audio device through the speakers of the HP103

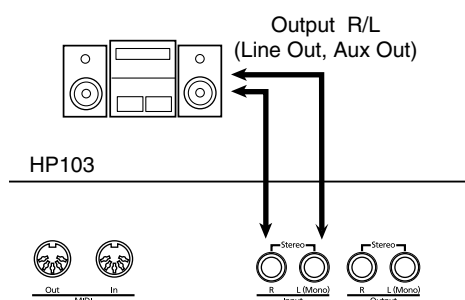

○ Use the following procedure when turning on the power.

1. Turn on the power of the connected device.
2. Turn on the power of the HP103.
3. Adjust the volume of each device.

- * You cannot use the HP103 to adjust the volume of the connected sound generating device.

Turning off the power

1. Set the volume of the HP103 and of the connected devices to the minimum position.
2. Turn off the power to the HP103.
3. Turn off the connected equipment.

Connecting to a Computer

You can use a USB MIDI interface cable (sold separately) to connect the HP103 to your computer.

If the HP103 is connected to a computer in which sequencer software such as Roland's "Visual MT" is installed, a song you've recorded on the HP103 can be saved on your computer.

Connection Examples

- * To prevent malfunction and/or damage to speakers or other devices, always turn down the volume, and turn off the power on all devices before making any connections.
- * In order to make connections to your computer, you must install "MIDI driver" software on your computer. For details, refer to the owner's manual for your MIDI interface.

Use a USB MIDI interface cable to connect the USB connector of your computer to the MIDI connectors of the HP103.

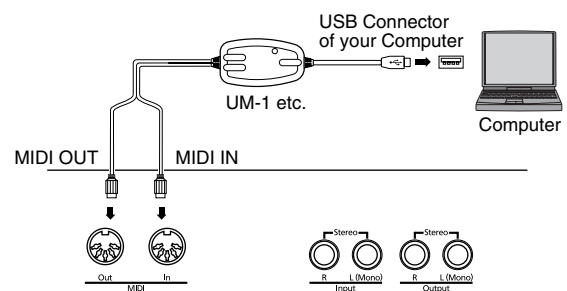

Chapter 6. Connecting External Devices

Connecting MIDI Devices

By connecting an external MIDI device and exchanging performance data, you can control the performances on one device from the other. For instance, you can output sound from the other instrument or switch tones on the other instrument.

■ What's MIDI?

MIDI stands for Musical Instrument Digital Interface, an international standard which allows performance information to be communicated among electronic musical instruments and computers.

The HP103 provides MIDI connectors, which allow performance data to be exchanged with external devices. When these connectors are used to connect the HP103 to external devices, an even wider range of possibilities becomes available.

* A separate publication titled "MIDI Implementation" is also available. It provides complete details concerning the way MIDI has been implemented on this unit. If you should require this publication (such as when you intend to carry out byte-level programming), please contact the nearest Roland Service Center or authorized Roland distributor.

Connection Examples

* To prevent malfunction and/or damage to speakers or other devices, always turn down the volume, and turn off the power on all devices before making any connections.

Playing the HP103 from a MIDI sequencer/ Recording an HP103 performance on a MIDI sequencer

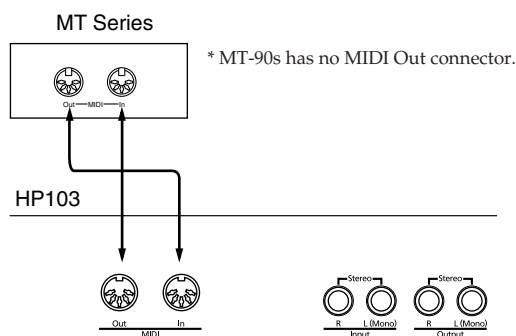

* Set Local Off if you have connected the HP103 to a MIDI sequencer. Refer to "Switching Local Control on and Off" (p. 41). Also set your MIDI sequencer to MIDI Thru mode (so that messages received at MIDI IN will be re-transmitted without change from MIDI OUT). For details, refer to the owner's manual of your MIDI sequencer.

Perform on the HP103 to play a MIDI sound generator

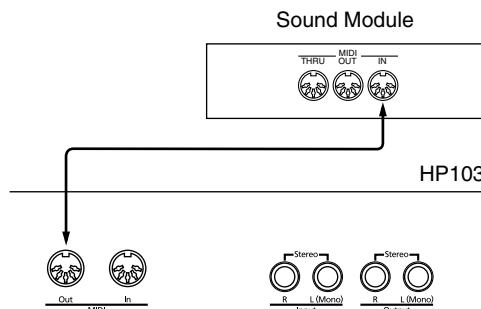

Making MIDI-related Settings

Here's how you can set the transmit channel and other MIDI-related settings.

How to enter function mode

1. Hold down the [Split] button and press the [Reverb] button.

The HP103 switches to the set mode.

The indicators for the [Split] and [Reverb] buttons and the button to which the function is assigned start flashing.

Setting various functions

2. Press the button to which the desired function is assigned.

The indicators for pressed button, [Split] button, and [Reverb] button flash.

For details on the contents of each function, refer to the explanations that follow.

3. Press the [-] or [+] button to change the value.

If you press the [-] and [+] buttons simultaneously, the setting will return to the original value.

How to exit function mode

4. Press either the [Split] button or the [Reverb] button.

The button's indicator will return to the previous state.

■ MIDI Send Channel Settings

MIDI features sixteen MIDI channels, numbered 1–16. Simply connecting a cable is not enough for communication to take place. The connected devices must be set to use the same MIDI channels. Otherwise, no sound will be produced, and no sounds can be selected.

* The HP103 receives all channels 1–16.

If you press the **[Strings]** button in step 2 of “Making MIDI-related settings” (p. 40), a display like the following will appear.



Value 1–16
Power-up default setting 1

■ Switching Local Control on and Off

When connecting a MIDI sequencer, set Local Control to “OFF.”

As illustrated, information describing what has been played on the keyboard is passed to the internal sound generator over two different routes, (1) and (2). As a result, you hear overlapping or intermittent sounds. To prevent this from happening, route (1) must be severed, by setting the unit to what is known as “Local Off.”

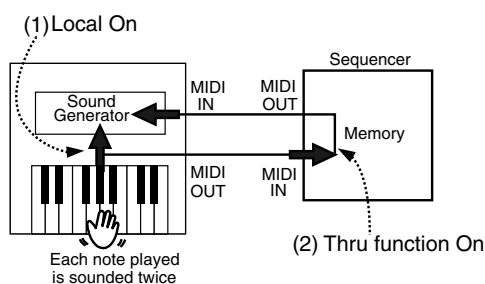

Local Control ON: The keyboard and the internal sound generator are in a linked state.

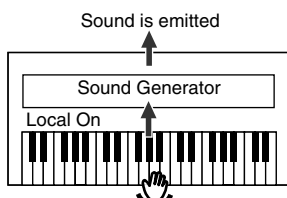

Local Control OFF: The keyboard and the internal sound generator are in an unlinked state. No sound will be produced by the keyboard when it is played.

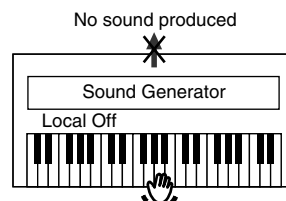

* When a Roland MT series instrument is connected, it is not necessary to make the Local Off setting. MT units transmit Local Off messages when their power is switched on. If you turn on the power in the order of the HP103 → MT series, Local Off will be set automatically.

If you press the **[Variation]** button in step 2 of “Making MIDI-related settings” (p. 40), a display like the following will appear.



Value On, OFF
Power-up default setting On

■ Transmitting a Performance You Recorded

If you want to transmit a performance recorded on the HP103 to an external MIDI device or computer, turn this setting “On.” If this is “OFF,” the data will not be transmitted.

If you press the **[Play]** button in step 2 of “Making MIDI-related settings” (p. 40), a display like the following will appear.



Value On, OFF
Power-up default setting OFF

If you wish to save the performance recorded on the HP103, use the following procedure. In this situation, your external sequencer is set its MIDI Thru feature to be OFF. For details, refer to the owner’s manual of your MIDI sequencer.

1. Connect a MIDI sequencer such as the MT series (p. 40).
2. Record the performance on the HP103 (p. 30).
3. Set this setting to “On.”
4. Start recording with the connected MIDI sequencer.
5. Start playback of the recorded song on the HP103.
6. When playback ends, stop recording with the connected MIDI sequencer.
7. Use a connected MIDI sequencer to save the data on a floppy disk or other media.

Troubleshooting

If you think there's a problem, read this first.

Case	Cause/Remedy
The power doesn't come on	Is the power cord connected and plugged in correctly? (p. 10)
The button doesn't work	Is the panel locked? (p. 38) Is the Tone locked? (p. 38) Turn the power off, then back on.
No sound is heard	Is the volume level of the HP103 turned all the way down? (p. 12)
	Are headphones plugged in? (p. 11) Has a plug remained connected to the Phones jack? When headphones are connected, the keyboard's speaker stops playing.
	Is Local Off selected? When Local Control is set to OFF, no sound is produced by playing the keyboard. Set Local Control to "On" (p. 41).
	Is V-LINK switched on? While V-LINK is switched on, no sound is produced when you press any of the twelve keys at the left end of the keyboard (p. 38).
No sound is heard (when a MIDI instrument is connected)	Have all devices been switched on?
	Are the MIDI cables connected correctly?
	Does the MIDI channel match the connected instrument? (p. 41)
Sounds are heard twice (doubled) when the keyboard is played	Is the HP103 in Dual play? (p. 23)
	When the HP103 is connected to an external sequencer, set it to the Local OFF mode (p. 41). Alternatively, the sequencer could be set so its MIDI Thru feature is OFF.
The tone has changed in the Split or Dual play	If you use Dual play or Split play with a Tone button for which tone number 3 or 4 is selected, tone number 1 will be selected for that Tone button (p. 16).
	Some tones assign the tone that had been selected before you pressed the [Split] button to the left hand area of the keyboard. Please refer to "Tone List" (p. 44).
Tone doesn't change	Is the panel locked? (p. 38) Is the Tone locked? (p. 38) Turn the power off, then back on.
	Are the indicators for the [Split] and [Reverb] buttons flashing? Setting of functions is in progress. Press the [Split] or [Reverb] button to exit function mode (p. 35, p. 40).

Case	Cause/Remedy
Not all played notes are sounded	The maximum number of notes that the HP103 can play simultaneously is 64. Frequent use of the damper pedal when playing along with a song may result in performance data with too many notes, causing some notes to drop out.
The tuning or pitch of the keyboard or song is off	Have you set Transpose? (p. 22)
	Are the settings for the "Temperament" and "Stretch Tuning" correct? (p. 36)
	Is the setting for the "Master Tuning" correct? (p. 36)
Song doesn't play back/ Only the sound of a particular instrument in a song does not play	Are the indicator for the Track buttons ([Left] and [Right] buttons) extinguished? (p. 29) If the button indicator is out, the music on that track is not heard. Press the track button so the indicator is illuminated.
Can't record	Has one of the track buttons for recording been selected? (p. 30–p. 33)
Tempo of recorded song or metronome is off	If you select an internal song in which the tempo changes during the song, and then record, the tempo will change in the same way for the performances. The tempo of the metronome will also change in the same way.
	If you record additional material without erasing the previously recorded song, the song will be recorded at the first-recorded tempo. Please erase the previously recorded song before you re-record (p. 34).
The recorded performance has disappeared	Any performance that has been recorded is deleted when the power to the HP103 is turned off. A performance cannot be restored once it's been deleted.
Depressing a pedal has no effect, or the pedal effect doesn't stop	Is the pedal connected correctly? Make sure the pedal cord is securely connected to the pedal jack on the rear of the unit (p. 10).
The pedal rattles	Adjust the adjuster underneath the pedal so that the adjuster presses firmly against the floor surface (p. 12).
Reverberation still audible even with Reverb turned off	Since the H103's piano sounds accurately reproduce the depth and reverberation of the original acoustic piano, you may find that reverberation is audible when the Grand Space is enabled. If you want to eliminate the reverberation, turn off the Grand Space function (p. 18-19).

Error Messages/Other Messages

Case	Cause/Remedy
In the upper range, the sound changes abruptly beyond a certain key	On an acoustic piano, notes in the upper one and a half octaves of the keyboard continue to sound until they decay naturally, regardless of the damper pedal. There is a difference in the timbre as well. Roland pianos faithfully simulate such characteristics of the acoustic piano. On the HP103, the range that is unaffected by the damper pedal will change depending on the Key Transpose setting.
A High-pitched whine is produced	<p>When listening through headphones: Some of the more flamboyant and effervescent piano tones feature an ample high-end component, which may make the sound appear to have metallic reverberation added. Since this reverberation becomes particularly audible when supplemented by heavy reverb, you may be able to diminish the problem by reducing the amount of reverb applied to the sound.</p> <p>When listening through speakers: Here, a different cause (such as resonance produced by the HP103) would be suspect. Consult your Roland dealer or nearest Roland Service Center.</p>

Case	Cause/Remedy
The bass range sounds odd, or there is a vibrating resonance	<p>When listening through speakers: Playing at loud volumes may cause instruments near the HP103 to resonate. Resonation can also occur with fluorescent light tubes, glass doors, and other objects. In particular, this problem occurs more easily when the bass component is increased, and when the sound is played at higher volumes. Use the following measures to suppress such resonance.</p> <ul style="list-style-type: none"> • Place speakers so they are 10–15 cm from walls and other surfaces. • Reduce the volume. • Move the speakers away from any resonating objects. <p>When listening through headphones: Here, a different cause would be suspect. Consult your Roland dealer or nearest Roland Service Center.</p>
The volume level of the instrument connected to Input jacks is too low	<p>Could you be using a connection cable that contains a resistor? Use a connection cable that does not contain a resistor.</p>

Error Messages/Other Messages

Display	Meaning
USr	User Song. Stores recorded performances (p. 31).
U ^r .	The “.” in the display indicates that there is performance material already recorded (p. 31).
S.	Internal song number (p. 13).
PU	This appears when a song with a pickup (a song that does not start on the first beat) is played back.
dEL	This appears when you attempt to delete a recorded song (p. 30, p. 34).
E.32	The amount of performance information is too large, and further recording is not possible.
E.41	A problem such as a loose MIDI cable occurred. Make sure the MIDI cables are correctly hooked up.
— — —	V-LINK function is On (p. 38).

* Error messages are indicated by an “E.” before the number. Press any button, and you can cancel the error message.

Tone List

Button name	[Variation]	[Split] Off	[Split] On		
		Tone	[Variation] Dark	[Variation] Red	[Variation] Green
[Piano]	Dark	Grand Piano	Grand Piano / Acoustic Bass	Grand Piano / Acoustic Bass + Cymbal	Grand Piano / Strings
	Red	Mellow Piano	Mellow Piano / Acoustic Bass	Mellow Piano / Acoustic Bass + Cymbal	Mellow Piano / Strings
	Green	Piano + Strings			
	Orange	Piano + Choir			
[E. Piano]	Dark	Electric Piano1	Electric Piano1 / Electric Bass	Electric Piano1 / Acoustic Bass	Electric Piano1 / Strings
	Red	Electric Piano2	Electric Piano2 / Electric Bass	Electric Piano2 / Acoustic Bass	Electric Piano2 / Strings
	Green	Vibraphone			
	Orange	Electric Piano + Choir			
[Harpsi]	Dark	Harpsichord	Harpsichord / Strings	Harpsichord / Organ Flute	Harpsichord / Acoustic Bass
	Red	Coupled Harpsichord	Coupled Harpsichord / Strings	Coupled Harpsichord / Organ Flute	Coupled Harpsichord / Acoustic Bass
	Green	Harpsichord + Strings			
	Orange	Harpsichord + Choir			
[Organ]	Dark	Church Organ 1	Church Organ 1 / Organ Bass	Church Organ 1 / Strings	Church Organ 1 / Choir
	Red	Organ Flute	OrganFlute / Organ Bass	OrganFlute / Strings	OrganFlute / Choir
	Green	Rotary Organ			
	Orange	Church Organ 2			
[Strings]	Dark	Slow Strings	Strings / Pizzicato	Slow Strings / Choir	Flute / Slow Strings
	Red	Jazz Scat	Jazz Scat / Voice Bass	Jazz Scat / Acoustic Bass	Jazz Scat / Choir
	Green	Strings			
	Orange	Choir			

* A+B: simultaneously playing two tones

You can change the volume balance between the two tones, refer to "Adjusting the Volume Balance in Dual Play (Dual Balance)" (p. 23).

A/B: A, the right-hand tone; and B, the left-hand tone in Split play

Internal Song List

Song No.	Song Name	Composer	Copyright
S. 1	La Fille aux Cheveux de Lin	C. Debussy	© 2004 Roland Corporation
S. 2	Late Night Chopin	F. Chopin/ Arranged by John Maul	© 2002 Roland Corporation
S. 3	Fly Free	John Maul	© 1998 Roland Corporation
S. 4	L'éveil del l'amour	Masashi & Kazuko Hirashita	© 2000 Roland Corporation
S. 5	Sonate für Klavier No. 15	W. A. Mozart	© 1996 Roland Corporation
S. 6	Liebesträume III	F. Liszt	© 2001 Roland Corporation
S. 7	Étude, op.10-3	F. Chopin	© 2001 Roland Corporation
S. 8	Je te veux	E. Satie	© 1997 Roland Corporation
S. 9	Valse, op.64-1	F. Chopin	© 2001 Roland Corporation
S. 10	Golliwog's Cake walk	C. Debussy	© 1995 Roland Corporation
S. 11	Fantaisie-Improptu	F. Chopin	© 2001 Roland Corporation
S. 12	1ère Arabesque	C. Debussy	© 1995 Roland Corporation
S. 13	An der schönen, blauen Donau	J. Strauss (II)	© 1996 Roland Corporation
S. 14	Auf Flügeln des Gesanges	F. Mendelsshon	© 1996 Roland Corporation
S. 15	Mazurka No.5	F. Chopin	© 1995 Roland Corporation
S. 16	1ère Gymnopédie	E. Satie	© 1997 Roland Corporation
S. 17	Étude, op.25-1	F. Chopin	© 1995 Roland Corporation
S. 18	Clair de Lune	C. Debussy	© 1998 Roland Corporation
S. 19	Étude, op.10-5	F. Chopin	© 2001 Roland Corporation
S. 20	Doctor Gradus ad Parnassum	C. Debussy	© 1995 Roland Corporation
S. 21	Grande Valse Brillante	F. Chopin	© 1995 Roland Corporation
S. 22	La prière d'une Vierge	T. Badarzewska	© 1996 Roland Corporation
S. 23	Course en Troïka	P. Tchaikovsky	© 1996 Roland Corporation
S. 24	To The Spring	E. Grieg	© 1996 Roland Corporation
S. 25	Valse, op.64-2	F. Chopin	© 1996 Roland Corporation
S. 26	Radetzky Marsch	J. Strauss (I)	© 1996 Roland Corporation
S. 27	Träumerei	R. Schumann	© 1996 Roland Corporation
S. 28	Moments Musicaux III	F. Schubert	© 1996 Roland Corporation
S. 29	Prélude, op.28-15	F. Chopin	© 1996 Roland Corporation
S. 30	The harmonious blacksmith	G. Handel	© 1996 Roland Corporation
S. 31	Ungarische Tänze V	J. Brähms	© 1996 Roland Corporation
S. 32	Türkischer Marsch	L. v. Beethoven	© 1996 Roland Corporation
S. 33	Nocturne No.2	F. Chopin	© 1996 Roland Corporation
S. 34	Frühlingslied	F. Mendelsshon	© 1996 Roland Corporation
S. 35	Präludium	J. S. Bach	© 1996 Roland Corporation
S. 36	Jägerlied	F. Mendelsshon	© 1996 Roland Corporation
S. 37	Menuet Antique	M. Ravel	© 1996 Roland Corporation
S. 38	Für Elise	L. v. Beethoven	© 1996 Roland Corporation
S. 39	Türkischer Marsch	W. A. Mozart	© 1996 Roland Corporation
S. 40	Ständchen	F. Schubert	© 1996 Roland Corporation
S. 41	Humoreske	A. Dvořák	© 1996 Roland Corporation
S. 42	Blumenlied	G. Lange	© 1996 Roland Corporation
S. 43	Alpenglöckchen	T. Oesten	© 1996 Roland Corporation

Internal Song List

Song No.	Song Name	Composer	Copyright
S. 44	Menuett G dur	L. v. Beethoven	© 1996 Roland Corporation
S. 45	Venezianisches Gondellied	F. Mendelsshon	© 1996 Roland Corporation
S. 46	Alpenabendröte	T. Oesten	© 1996 Roland Corporation
S. 47	Farewell to the Piano	L. v. Beethoven	© 1996 Roland Corporation
S. 48	Brautchor	R. Wagner	© 1996 Roland Corporation
S. 49	Battle of Waterloo	W. Anderson	© 1996 Roland Corporation
S. 50	Wiener Marsch	C. Czerny	© 1996 Roland Corporation
S. 51	Le Coucou	L. C. Daquin	© 1996 Roland Corporation
S. 52	Menuett G dur	J. S. Bach	© 1992 Roland Corporation
S. 53	Spinnerlied	A. Ellmenreich	© 1996 Roland Corporation
S. 54	Gavotte	F. Gossec	© 1996 Roland Corporation
S. 55	Heidenröslein	G. Lange	© 1996 Roland Corporation
S. 56	Zigeuner Tanz	H. Lichner	© 1996 Roland Corporation
S. 57	La Cinquantaine	G. Marie	© 1996 Roland Corporation
S. 58	Csikos Post	H. Necke	© 1996 Roland Corporation
S. 59	Dolly's Dreaming Awakening	T. Oesten	© 1996 Roland Corporation
S. 60	La Violette	L. Streabbog	© 1996 Roland Corporation
S. 61	Fröhlicher Landmann	R. Schumann	© 1996 Roland Corporation
S. 62	Sonatine op.36-1	M. Clementi	© 1996 Roland Corporation
S. 63	Sonatine op.20-1	F. Kuhlau	© 1996 Roland Corporation
S. 64	Sonatine No.5	L. v. Beethoven	© 1996 Roland Corporation
S. 65	Hungarian Rag: Hungarian Dance No. 5 Ragtime Arrangement For Solo Piano	J. Brahms/ Arranged by John Maul	© 1996 Roland Corporation
S. 66	Paganini Boogie: Jazz Variation Based on "Caprice No. 24 in A Minor"	N. Paganini/ Arranged by John Maul	© 1998 Roland Corporation

* All rights reserved. Unauthorized use of this material for purposes other than private, personal enjoyment is a violation of applicable laws.

Profile

John Maul

John Maul is a musician, composer and arranger having graduated from the Royal Academy of Music in London. John's work encompasses studio recordings and live performances including work with top UK Jazz artists.

His writing credits include commercial music for BBC radio and television, as well as scoring jazz and classical works.

Having been a product specialist for Roland U.K., John is now actively involved in music software composing/programming for both Roland Japan and various music publishers. Quite recently his "Musical Picture Book," a volume of original piano music encompassing all standards of musical ability, which included the piano and orchestral accompaniment data in SMF format, was published and printed.

Easy Operation List

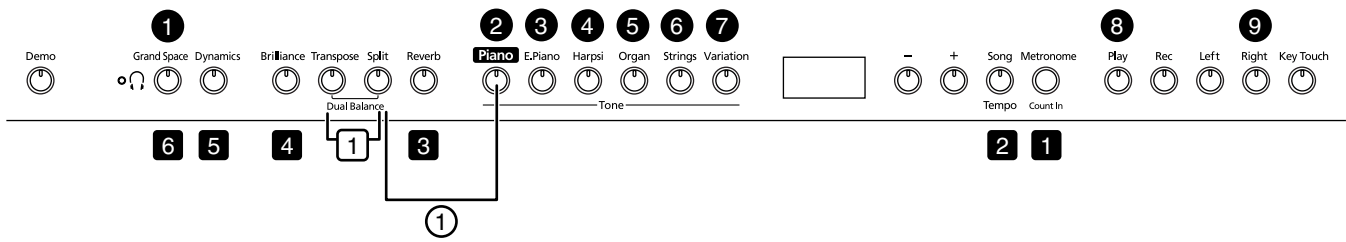

No.	You want to	Buttons	Page
Press the [Split] and [Piano] buttons simultaneously.			
①	Twin Piano Mode	[Split]+ [Piano]	p. 27
Press the [Split] and [Reverb] buttons simultaneously, and press the [●] button.			
①	Grand Space Mode	[Split]+ [Reverb] → [Grand Space]	p. 37
②	Master Tuning	[Split]+ [Reverb] → [Piano]	p. 36
③	Selecting a temperament Specifying the keynote	[Split]+ [Reverb] → [E. Piano] → [E. Piano] + key	p. 36
④	Stretch tuning	[Split]+ [Reverb] → [Harpsi]	p. 37
⑤	Applying the damper pedal to the left-hand keyboard area	[Split]+ [Reverb] → [Organ]	p. 37
⑥	MIDI send channel settings	[Split]+ [Reverb] → [Strings]	p. 41
⑦	Local Control	[Split]+ [Reverb] → [Variation]	p. 41
⑧	Transmitting a recorded performance	[Split]+ [Reverb] → [Play]	p. 41
⑨	V-LINK	[Split]+ [Reverb] → [Right]	p. 38
Press the [□] button, and press the [-] or [+] button.			
①	Dual Balance	[Transpose] + [Split] → [-][+]	p. 23
Hold down the [■] button and press the [-] or [+] button.			
①	Metronome volume	[Metronome/Count In] + [-] [+]	p. 26
②	Beat of metronome	[Song/Tempo] + [-] [+]	p. 26
③	Depth of the Reverb effect	[Reverb] + [-] [+]	p. 21
④	Damper pedal's resonance level	[Brilliance] + [-] [+]	p. 35
⑤	Dynamic Emphasis setting	[Dynamics] + [-] [+]	p. 20
⑥	Grand Space setting	[Grand Space] + [-] [+]	p. 18 p. 19
Hold down the [Split] or [Transpose] button and press the key.			
	Split Point	[Split] + key	p. 25
	Key Transpose	[Transpose] + key	p. 22

MIDI Implementation Chart

Function...	Transmitted	Recognized	Remarks
Basic Channel Default Changed	1 1-16	1 1-16	
Mode Default Messages Altered	Mode 3 x *****	Mode 3 x	
Note Number : True Voice	15-113 *****	0-127 15-113	
Velocity Note ON Note OFF	O x 8n v=64	O x	
After Touch Key's Ch's	x x	x x	
Pitch Bend	x	x	
Control Change 6, 38 7 11 64 66 67 91 100, 101	O x x O O O O O O	O O O O O O O O	Data entry Volume Expression Hold 1 Sostenuto Soft Effect 1 (Reverb) RPN LSB, MSB
Prog Change : True Number	O (0...117) *****	O (0-127) 0...117	
System Exclusive	O	O	
System Common : Song Pos : Song Sel : Tune	x x x	x x x	
System Real Time : Clock : Commands	x x	x x	
Aux Message : All sound off : Reset all controllers : Local Control : All Notes OFF : Active Sense : Reset	x x x x O x	x O O O (123-127) O x	
Notes			

Mode 1 : OMNI ON, POLY Mode 2 : OMNI ON, MONO O : Yes
Mode 3 : OMNI OFF, POLY Mode 4 : OMNI OFF, MONO X : No

Main Specifications

Keyboard	
Keyboard	88 keys (Progressive Hammer Action Keyboard)
Touch Sensitivity	Touch: Light, Medium, Heavy, Fixed
Keyboard Modes	Whole, Dual (volume balance adjustable), Split (split point adjustable)
Sound Generator	
Max. Polyphony	64 voices
Tones	5 groups 20 variations
Temperament	7 types, selectable tonic
Stretched Tuning	2 types
Master Tuning	415.3 Hz–466.2 Hz (adjustable in increments of 0.1 Hz)
Transpose	Key Transpose (-6–+5 in semitones)
Effects	Grand Space, Dynamic Emphasis, Reverb (8 levels), Chorus (for E. Piano only), Damper Resonance (for Piano only, 8 levels)
Metronome	
Beat	2/2, 0/4, 2/4, 3/4, 4/4, 5/4, 6/4, 7/4, 3/8, 6/8, 9/8, 12/8
Volume	9 levels
Recorder	
Tracks	2 tracks
Song	1 song
Note Storage	Approx. 5,000 notes
Tempo	Quarter note = 20–250
Resolution	96 ticks per quarter note
Control	Play/Stop, Rec, Tempo, All Song Play, Track Select
Preset Songs	66 songs + 9 Tone Demo Songs
Others	
Rated Power Output	25 W x 2
Speakers	12 cm x 2
Display	Beat LED 7-segment, 3-digit LED Headphones indicator
Control	Volume, Brilliance (3 steps)
Pedals	Damper, Soft, Sostenuato
Other Functions	Panel Lock, Tone Lock
Connectors	Output jacks (L/Mono, R), Input jacks (L/Mono, R), Headphones jack x 2 (Stereo), MIDI connectors (In, Out)
Power Supply	AC 117 V / AC 230 V / AC 240 V
Power Consumption	55 W
Dimensions (including piano stand)	1,388 (W) x 425 (D) x 836 (H) mm / 54-11/16 (W) x 16-3/4 (D) x 32-15/16 (H) inches (HP103-MH) 1,398 (W) x 427 (D) x 837 (H) mm / 55-1/16 (W) x 16-13/16 (D) x 33 (H) inches (HP103-PE)
	1,388 (W) x 425 (D) x 1,025 (H) mm / 54-11/16 (W) x 16-3/4 (D) x 40-3/8 (H) inches (including music rest: HP103-MH) 1,398 (W) x 427 (D) x 1,027 (H) mm / 55-1/16 (W) x 16-13/16 (D) x 40-7/16 (H) inches (including music rest: HP103-PE)
Weights (including piano stand)	53 kg / 117 lbs (HP103-MH/PE)
Accessories	Owner's manual, Roland 60 Classical Piano Masterpieces, Power Cord, Headphones Hook, Music Rest

* In the interest of product improvement, the specifications and/or appearance of this unit are subject to change without prior notice.

Index

- A**
AC inlet 10
Adjuster 12
All Song Play 13
Audio Equipment 39
- B**
Beat 26
[Brilliance] knob 12
- C**
Computer 39
Count-In 28
- D**
Damper pedal 12, 37
 Resonance 35
Damper Resonance 12, 35
Demo
 Demo of the Functions 15
 Tone Demo 14
Dual Balance 23
Dual Play 23
Dynamic Emphasis 20
- E**
Effects (Reverb) 21
Erase 34
- F**
Function 35
 MIDI-related Settings 40
- G**
Grand Space 18–19
- H**
Headphone Hook 11
Headphones 11
- I**
Internal Song 13
- K**
Key Touch 17
- L**
Lid 10
Local Control 41
- M**
Master Tuning 36
Metronome 25
 Volume 26
MIDI 40
MIDI channel 41
MIDI Devices 40
Music Holder 11
Music Rest 10
- P**
Panel Lock 38
Pedal 12
Pedal Cable 10
Pedal jack 10
Phones jack 11
Play
 All Songs Continuously 13
 Along with the built-in songs 28
 Each Hand 29
 Selecting a song 13
Power 11
Power Cord 10
Power Indicator 11
[Power On] switch 11
- R**
Record 30
 Along with a Song 32
 Each Hand 33
 Erasing Performances 34
 New Song 31
Reverb 21
 Depth 21
- S**
Soft pedal 12
Sostenuto pedal 12
Split Play 24
Split Point 25
Stretch Tuning 37
- T**
Temperament 36
Tempo 25, 28
Tone 16
Tone button 16
Tone Group 16
Tone Lock 38
Track button 29, 33
Transpose 22
[Transpose] button 22
Tuning Curve 37
Twin Piano Mode 27
- V**
Variation tone 16
V-LINK 38
Volume
 Metronome 26
[Volume] knob 12

MEMO

MEMO

MEMO



For EU Countries

This product complies with the requirements of European Directives EMC 89/336/EEC and LVD 73/23/EEC.

For the USA

FEDERAL COMMUNICATIONS COMMISSION RADIO FREQUENCY INTERFERENCE STATEMENT

This equipment has been tested and found to comply with the limits for a Class B digital device, pursuant to Part 15 of the FCC Rules. These limits are designed to provide reasonable protection against harmful interference in a residential installation. This equipment generates, uses, and can radiate radio frequency energy and, if not installed and used in accordance with the instructions, may cause harmful interference to radio communications. However, there is no guarantee that interference will not occur in a particular installation. If this equipment does cause harmful interference to radio or television reception, which can be determined by turning the equipment off and on, the user is encouraged to try to correct the interference by one or more of the following measures:

- Reorient or relocate the receiving antenna.
- Increase the separation between the equipment and receiver.
- Connect the equipment into an outlet on a circuit different from that to which the receiver is connected.
- Consult the dealer or an experienced radio/TV technician for help.

This device complies with Part 15 of the FCC Rules. Operation is subject to the following two conditions:

- (1) This device may not cause harmful interference, and
- (2) This device must accept any interference received, including interference that may cause undesired operation.

Unauthorized changes or modification to this system can void the users authority to operate this equipment.
This equipment requires shielded interface cables in order to meet FCC class B Limit.

For Canada

NOTICE

This Class B digital apparatus meets all requirements of the Canadian Interference-Causing Equipment Regulations.

AVIS

Cet appareil numérique de la classe B respecte toutes les exigences du Règlement sur le matériel brouilleur du Canada.

This owner's manual is printed on recycled paper.